



# ELECTRICAL EQUIPMENT

Accessories



## CONTENT

Introduction		4
Plugs & sockets universal	➤ Surface / Panel mounted	7
Plugs & sockets	➤ 3 and 4 poled	11
Plugs & sockets	➤ 7 poled	15
Plugs & sockets	➤ 13 and 15 poled ➤ VBG 14 and 17 poled	25
Plugs & sockets	➤ ABS / EBS	31
Plugs & sockets	➤ Nato	37
Coil cables with plugs	➤ 2 & 5 poled	45
Coil cables with plugs	➤ 7 poled	47
Coil cables with plugs	➤ 13 & 15 poled	51
Coil without plugs		53
Adapter & Connection cables		55
Air brake tube & coils		63
Junction boxes		67
Electronic control units & SIMAC		77
Standard cables for lighting systems		89
Connectors		85
Installation material	➤ Wires, cables, cable ties	105
Installation material	➤ Starter cables	121
Installation material	➤ Battery terminals ➤ Engine earth straps	125
Power relays		129
Fuses		139
Blade receptacles and terminals		155
Operation units		171
Inverters		175
Reversing alarm		181
Contact Allocation		183

# ERMAX® – YOUR PARTNER FOR COMPLETE LIGHTING SYSTEMS

## ERMAX A/S

- develops, manufactures and distributes a wide range of products within lighting, junction boxes and cable systems for commercial vehicles and industrial applications.

A unique set-up with a combination of our factory in Denmark and licensed production with our own tools at a number of selected and exclusively certified partners worldwide, offers an extensive, highly competitive and qualitative range of products.

## The Brand - ERMAX®

Founded in 1948 the Ermax® lighting technology has been manufactured for the automotive industry for almost 7 decades.

Ermax is the partner, when it comes to understanding and fulfilling the needs of lighting; with tail lights, warning lights, beacons, side markers or work lights – nowadays bulb, LED as well as in hybrid technologies. These lighting components are being offered within a complete solution concept of ADR approved

cables and, where required, junction boxes as well as mounting hardware. All cable sets are configured with multiple connector types to ensure the best lifetime service ability.

## Why Ermax® Lighting Systems ?

Partnership through quality, reliability and competence.

Our competence in partnering with you, is our extensive experience in being an OEM partner with quality and on time delivery as daily focus to ensure expectations and execution match entirely with your requirements.

All our products hold the necessary certifications for E-marking, IP-protection, ADR-approval and design predictions to ensure exclusive design and durability as well as non-violation of patents.

**With reliable and planned processes you will reach your goal safely with us as partner.**



ERMAX A/S, Kolding, Denmark

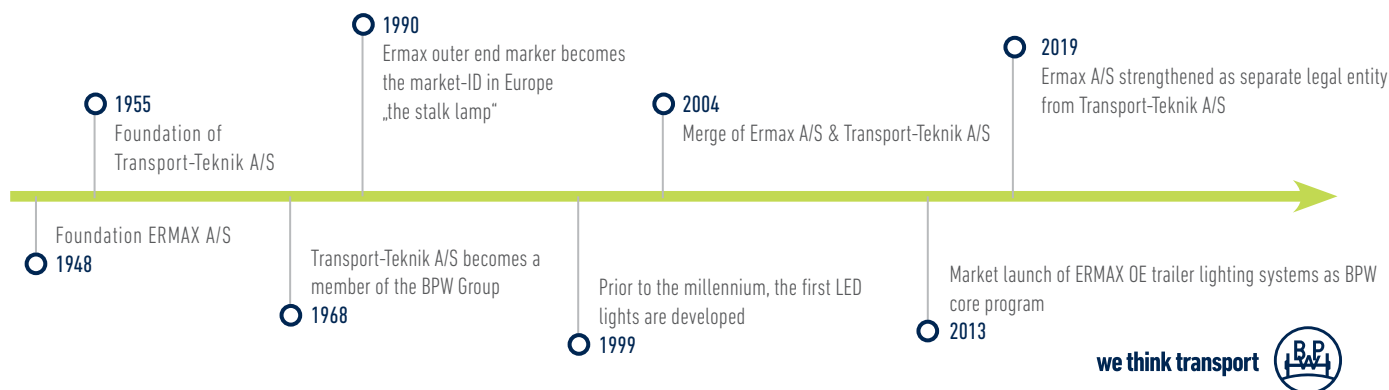

## DISTRIBUTION NETWORK WORLDWIDE

### Always close to you

As a member of the BPW Group, which operates worldwide, we have an unique sales and distribution network with local offices and support for the benefit of all of our business partners.



## SOLUTIONS – AS INDIVIDUAL AS YOUR TASKS AND REQUIREMENTS

As ERMAX customer you will achieve the following

- High quality for every area
- Vehicle-customised solutions
- Focus at the newest technology and innovative products with recognisable design
- Production companies with development competence under one roof
- Europe-wide after-sales-servicenent

ERMAX lighting systems

- Wide palette including cables, plugs and lights – all built according to customer requirements
- LED and SIMAC control unit built-in tail light
- ADR approved cable kits with 7 pole AMP 1.5 and Super Seal plugs
- Unbeatable, impact resistant and long life solutions



# PLUGS & SOCKETS - UNIVERSAL

Surface / panel mounted



### ISO 4165 - 2 poled



Pos 1



Pos 2

ISO Norm	Mounting	Plug type	Poled	Connection	Operation voltage	Consumption	Pos	Article No.
----------	----------	-----------	-------	------------	-------------------	-------------	-----	-------------

4165	Panel	Socket	2	Flat pin terminal	12V	8 A	1	<b>090 122 237</b>
------	-------	--------	---	-------------------	-----	-----	---	--------------------

#### Spare parts

Black hinged cover							2	<b>090 122 240</b>
--------------------	--	--	--	--	--	--	---	--------------------

### ISO 4165 - 1 or 2 poled



Pos 1



Pos 2



Pos 3



Pos 5

ISO Norm	Mounting	Plug type	Poled	Connection	Operation voltage	Consumption	Pos	Article No.
----------	----------	-----------	-------	------------	-------------------	-------------	-----	-------------

4165	Panel	Socket	1	Flat pin terminal	12V	8 A	1	<b>090 122 224</b>
4165	Panel	Socket	1	Flat pin terminal Mounting for beacons	12V	8 A	2	<b>098 295 651</b>
4165	Panel	Socket	2	Flat pin terminal Mounting for beacons	12V	8 A	3	<b>098 295 650</b>

#### Spare parts

Black hinged cover							5	<b>090 122 240</b>
--------------------	--	--	--	--	--	--	---	--------------------



ISO 4165 - 2 poled



ISO Norm	Plug type	Poled	Material	Connection	Operation voltage	Consumption	Universal plug	Article No.
4165	Plug	2	Plastic	Adapter and Screw terminals	12/24V	8 A	✓	090 126 633



# PLUGS & SOCKETS

3 & 4 POLED



DIN 9680 - 3 poled



Pos 1

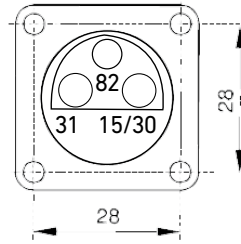

Pos 1



Pos 2

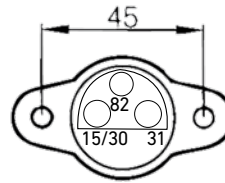

Pos 2



Pos 3

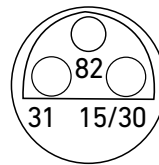

Pos 3

ISO Norm	Plugtype	Poled	Material	Connection	Operation voltage	Consumption	Pos	Article No.
9680	Socket	3	Plastic	Flat pin terminal	12/24V	2x25; 1x5 A	1	<b>090 133 306</b>
9680	Socket	3	Plastic	Flat pin terminal	12/24V	2x25; 1x5 A	2	<b>090 133 308</b>
9680	Plug	3	Plastic	Flat pin terminal	12/24V	2x25; 1x5 A	3	<b>090 133 317</b>



Pos 1



Pos 2



Pos 3

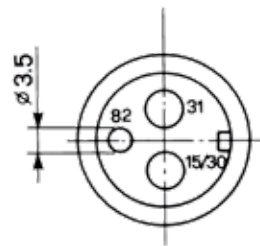

Pos 3



Pos 4

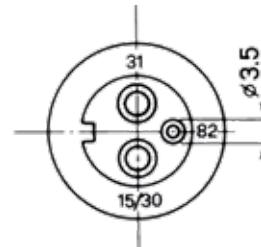

Pos 4

Plug type	Poled	Material	Connection	Operation voltage	Consumption	Pos	Article No.
Socket	3	Plastic	Screw terminals	12/24V	20 A	1	<b>090 133 301</b>
Plug	3	Plastic	Screw terminals	12/24V	16 A	2	<b>090 133 312</b>
Socket	3	Plastic	Flat pin terminals	12/24V	2x25A; 1x5A	3	<b>090 133 304</b>
Plug	3	Plastic	Screw terminals	12/24V	2x25A; 1x5A	4	<b>090 133 315</b>

## DIN 72 575 A4 - 4 poled



Pos 1



Pos 2

ISO Norm	Plug type	Poles	Material	Connection	Operation voltage	Consumption	Pos	Article No.
DIN 72 575 A4	Socket	4	Plastic	Screw terminals	12V	20 A	1	<b>090 144 404</b>
DIN 72 575 A4	Plug	4	Plastic	Screw terminals	12V	20 A	2	<b>090 144 418</b>

# PLUGS & SOCKETS

7 POLED



ISO 1724 - 7 poled



Pos 1



Pos 2

ISO Norm	Plug type	Poles	Material	Connection	Operation voltage	Consumption	Fog light switch	Pos	Article No.
1724	Socket	7	Metal	Screw terminals	12V	20 A		1	090 147 311
1724	Plug	7	Metal	Screw terminals	12V	20 A		2	090 147 712



Pos 3



Pos 4



Pos 5

**Spare parts**

Gasket for socket ISO 1724	Pos. 3	090 147 914
Gasket for socket with 1 outlet	Pos. 4	090 147 923
Mounting angle for socket	Pos. 5	090 147 939



ISO 1724 - 7 poled



Pos 1



Pos 2



Pos 3



Pos 4



Pos 5



Pos 6

ISO Norm	Plug type	Poled	Material	Connection	Operation voltage	Consumption	Rubber cap	Pos	Article No.
1724	Socket	7	Plastic	Screw terminals	12V	20A		1	090 147 328
1724	Socket	7	Plastic	Flat pin terminal	12V	20A		2	090 147 329
1724	Socket	7	Plastic	Screw terminals	12V	20A		3	090 147 335
1724	Plug	7	Plastic	Screw terminals	12V	20A	✓	4	090 147 727
1724	Plug	7	Plastic	Screw terminals	12V	20A		5	090 147 716*
1724	Plug	7	Plastic	Screw terminals	12V	20A	✓	6	090 147 717

Spare parts

Gasket for socket ISO 1724	090 147 914
Gasket for socket with 1 outlet	090 147 923
Mounting angle for socket	090 147 939
Holder for plug suitable for 090 147 727	090 147 935
* 090 147 716 – With cable gland + extra rubber sealing for use of 1 or 2 cables	

## ISO 1724 - 7 poled



Socket with suspension device and extra gasket 8-10 mm

ISO Norm	Plug type	Poled	Material	Connection	Operation voltage	Consumption	Article No.
1724	Socket	7	Plastic	Screw terminals	12V	20 A	<b>090 147 808</b>

ISO 1185 - 7 poled



Pos 1



Pos 2



Pos 3



Pos 4

ISO Norm	Plugtype	Poled	Material	Connection	Operation voltage	Consumption	Pos	Article No.
1185	Plug	7	Aluminium	Screw terminals	24V	20 A	1	090 257 715
1185	Plug	7	Aluminium	Flat pin terminal	24V	20 A	2	090 257 716
1185	Plug	7	Plastic	Flat terminals	24V	20 A	3	090 257 721
1185	Plug	7	Plastic	Screw terminals		20 A	3	090 257 722
1185	Socket	7	Plastic	Screw terminals	24V	20 A	4	090 157 120

**Spare parts**

Rubber Sleeve	090 157 913
Mounting angle for socket	090 157 938

ISO 1185 - 7 poled



Pos 1



Pos 2



Pos 3

ISO Norm	Plug type	Poled	Material	Connection	Operation voltage	Consumption	Pos	Article No.
1185	Socket	7	Aluminium	Screw terminals	24V	20 A	1	090 157 112
1185	Socket	7	Plastic housing with alu-cover	Single flat pin terminal	24V	20 A	2	090 257 127
1185	Socket	7	Plastic housing with alu-cover	Dual flat pin terminal	24 V	20 A	2	090 257 130
1185	Socket	7	Aluminium housing with alu-cover	Single flat pin terminal	24V	20 A	3	090 257 134

**Spare parts**

Rubber sleeve	090 157 913
Mounting angle for socket	090 157 938

ISO 3731 - 7 poled



Pos 1



Pos 2



Pos 3

ISO Norm	Plug type	Poled	Material	Connection	Operation voltage	Consumption	Pos	Article No.
3731	Socket	7	Aluminium	Screw terminals	24V	20 A	1	090 157 117
3731	Socket	7	Plastic housing with alu-cover	Single flat pin terminal	24 V	20 A	2	090 257 123
3731	Socket	7	Plastic housing with alu-cover	Dual flat pin terminal	24 V	20 A	2	090 257 131
3731	Socket	7	Aluminium	Flat pin terminals	24V	20 A	3	090 257 118

**Spare parts**

Rubber Sleeve	090 157 913
Mounting angle for socket	090 157 938

ISO 3731 - 7 poled



ISO Norm	Plugtype	Poled	Material	Connection	Operation voltage	Consumption	Article No.
3731	Socket, contact 31 with contact sleeve	7	Plastic	Screw terminals	24V	20 A	090 157 123

**Spare parts**

Rubber Sleeve	090 157 913
Mounting angle for socket	090 157 938

ISO 3731 - 7 poled



Pos 1



Pos 2

ISO Norm	Plugtype	Poled	Material	Connection	Operation voltage	Consumption	Pos	Article No.
3731	Plug	7	Plastic	Flat terminals	24V	20 A	1	090 257 725
3731	Plug	7	Aluminium	Screw terminals	24V	20 A	2	090 257 718
3731	Plug	7	Aluminium	Flat terminals	24V	20 A	2	090 257 719

**Spare parts**

Mounting angle for socket	090 157 938
---------------------------	-------------

ISO 3732 - 7 poled



Pos 1



Pos 2

ISO Norm	Plug type	Poled	Material	Connection	Operation voltage	Consumption	Pos	Article No.
3732	Socket, contact 58 with contact sleeve	7	Black plastic with white cover	Screw terminals	12V	20 A	1	090 147 353
3732	Plug, contact 58 with contact pin	7	Black plastic with white snap insert	Screw terminals	12V	20 A	2	090 147 751

**Spare parts**

Flat flange gasket for socket	090 147 914
Mounting angle for socket	090 147 939





# PLUGS & SOCKETS

---

13 & 15 POLED

VBG 14 & 17 POLED



ISO 11446 - 13 poled



Pos 1



Pos 2

ISO Norm	Plug type	Poled	Material	Connection	Operation voltage	Consumption	Article No.
11446	Plug	13	Plastic	Screw terminals	12V	20 A	<b>090 163 602</b>
11446	Plug	13	Plastic	Screw terminals	12V	20 A	<b>090 163 604</b>

ISO 11446 - 13 poled



Pos 1



Pos 2

ISO Norm	Plug type	Poled	Material	Connection	Operation voltage	Consumption	Pos	Article No.
11446	Socket	13	Plastic	Screw terminals	12V	20 A	1	<b>090 163 402</b>
11446	Socket	13	Plastic	Screw terminals	12V	20 A	2	<b>090 163 410 *)</b>

\*) 090 163 410 - Switch off contact for rear fog lamp at motor vehicle

**Spare parts**

Flat flange gasket	<b>090 147 923</b>
--------------------	--------------------

ISO 4091 - 13 poled



Pos 1



Pos 2

ADR socket and plug with silverplated contact pins - suitable for tank vehicles

ISO Norm	Plug type	Poled	Material	Connection	Contact pins	Conductor cross section	Operation voltage	Consumption	Pos	Article No.
4091	Plug	13	Plastic	Crimp terminal	Silverplated	1x2,5 mm <sup>2</sup> + 12x1,0 - 1,5 mm <sup>2</sup>	24V	20A	1	090 264 513
4091	Socket	13	Plastic	Ccrimp terminal	Silverplated	1x2,5 mm <sup>2</sup> + 12x1,0 - 1,5 mm <sup>2</sup>	24V	20 A	2	090 264 311

Spare parts

Mounting angle, zinc-plated steel	090 198 918
-----------------------------------	-------------

ABS / EBS Parking socket 12/24V



Parking socket

ISO Norm	Plugtype	Material	ADR	Article No.
12098/7638-1/7638-2	Parking socket	Plastic	for ADR plug	090 190 008

ISO 12098 - 15 poled



Pos 1



Pos 2



Pos 3



Pos 4

ADR sockets with contact pins

ISO Norm	Plugtype	Poled	Material	Connection	Conductor cross section	Operation voltage	Pos	Article No.
12098	Socket, with contact pins	15	Plastic	Crimp terminals	3x2,5 mm <sup>2</sup> + 12x1,0 - 1,5 mm <sup>2</sup>	24V	1	090 265 404
12098	Socket, with contact pins	15	Plastic	Angled cable outlet	3x2,5 mm <sup>2</sup> + 12x1,0 - 1,5 mm <sup>2</sup>	24V	2	090 265 405
12098	Socket, with contact pins	15	Plastic	Screw terminals		24V	3	090 265 407
12098	Socket, with contact pins	15	Plastic	Angled cable outlet Shorter variant	Ø12,0 - 18,0 mm	24V	4	090 265 408

ISO 12098 - 15 poled



ADR plug with contact bushings

ISO Norm	Plugtype	Poled	Material	Connection	Conductor cross section	Operation voltage	Article No.
12098	Plug with contact bushings	15	Plastic	Crimp terminals	3x2,5mm <sup>2</sup> + 12x1,0-1,5mm <sup>2</sup>	24V	090 265 606
12098	Plug with contact bushings	15	Plastic	Screw terminals		24V	090 265 608

VBG connectors - 14 & 17 poled



Pos 1



Pos 2



Pos 3

MAX 25 A

SAL	Plug Type	Poled	Material	Cable gland	Crimp contact pins	Pos	Article No.
	Plug	14	Plastic	for cable Ø10,5-17,0 mm	Pin 1 & 2- 9,5 mm 25A Single pin - 6,5 „, 15A Doppel pin - 6,5 mm 15A	1	<b>090 166 360</b>
	Socket	14	Plastic	for cable Ø10,5-17,0 mm	Pin 1 & 2- 9,5 mm 25A Single pin - 6,5 „, 15A Doppel pin - 6,5 mm 15A	2	<b>090 166 290</b>
✓	Plug	14	Plastic	for cable Ø10,5-17,0 mm	Pin 1 & 2- 9,5 mm 25A Single pin - 6,5 „, 15A Doppel pin - 6,5 mm 15A	3	<b>090 166 361</b>



# PLUGS & SOCKETS

ABS / EBS



ISO 7638 - ABS/EBS 5/7 poled



Pos 1

EBS socket with contact pins

OBS: can be used for 5- and 7 pins installations

ISO Norm	Plug type	Poled	Material	Connection	Coding disc with colour designation	Conductor cross section	Operation voltage	Pos	Article No.
7638	ABS/EBS socket	5/7	Plastic	Screw terminals	✓		24V	1	090 290 077

**Spare parts**

Contact pin for socket, nickel-plated 1,0 - 1,5 mm <sup>2</sup> - Male	090 190 181
Contact pin for socket, nickel-plated 2,5 mm <sup>2</sup> - Male	090 190 182
Contact pin for socket, nickel-plated 4,0 mm <sup>2</sup> - Male	090 190 184
Contact pin for socket, nickel-plated 6,0 mm <sup>2</sup> - Male	090 190 186



ISO 7638 - ABS/EBS 5/7 poled



Pos 1



Pos 2

EBS plug with contact bushings

OBS: can be used for 5- and 7 pins installations

ISO Norm	Plug type	Poled	Material	Connection	Coding disc with colour designation	Conductor cross section	Operation voltage	Pos	Article No.
7638	ABS/EBS plug	5/7	Plastic	Crimp terminals	✓	5x1,5mm <sup>2</sup> + 2x4,0 mm <sup>2</sup> + 2x6,0 mm <sup>2</sup>	24V	1	090 290 071
7638	ABS/EBS plug	5/7	Plastic	Screw terminals	✓		24V	2	090 290 073

**Spare parts**

Contact bushings for plugs, tin-plated 1,0 - 1,5 mm <sup>2</sup>	090 190 191
Contact bushings for plugs, tin-plated 2,5 mm <sup>2</sup>	090 190 192
Contact bushings for plugs, tin-plated 4,0 mm <sup>2</sup>	090 190 194
Contact bushings for plugs, tin-plated 6,0 mm <sup>2</sup>	090 190 196

### Battery socket/plug, EURO



Pos 1



Pos 2

#### EURO battery socket/plug

Plugtype	IP Rating	Poled	Max. load	For Electro vehicles, forklifts	Contacts copper silver plated	Pos	Article No.
Battery socket	IP23	2	150V DC/ 160A	✓	✓	1	090 198 020
Battery plug	IP23	2	150V DC/ 160A	✓	✓	2	090 198 021

#### Spare parts

Handle for: 090 198 021	090 198 025
-------------------------	-------------

Battery plug



Pos 1



Pos 2



Pos 3



Pos 4

Silver plated copper contacts for soldering. Only connectors of same type and colour will interconnect.

Colour	Plug type	Poled	Conductor cross section	Max V/A	B x L	Pos	Article No.
Grey	Plug	2	6-16mm <sup>2</sup>	600V / 50A	35x47mm	1	090 198 050
Red	Plug	2	6-16mm <sup>2</sup>	600V / 50A	35x47mm	2	090 198 051
Black	Plug	2	6-16mm <sup>2</sup>	600V / 50A	35x47mm	3	090 198 052
Grey	Plug	2	25-50mm <sup>2</sup>	600V / 175A	50x78mm	1	090 198 060
Red	Plug	2	25-50mm <sup>2</sup>	600V / 175A	50x78mm	2	090 198 061
Grey	Plug	2	50-70mm <sup>2</sup>	600V / 350A	70x107mm	1	090 198 070
Red	Plug	2	50-70mm <sup>2</sup>	600V / 350A	70x107mm	2	090 198 071

Spare parts

Handle	4	090 198 079
--------	---	-------------



# PLUGS & SOCKETS

NATO



VG 96 917

VDA 72 593 A - Nato Socket, Olive



Pos 1



Pos 2

Nato socket with screw cover, olive

Plugtype	Material	Poled	Connection	Switching current	Switching current short term operation (10sec.)	Suitable for cable up to:	Operation voltage	Pos	Article No.
Socket with screw cover	Metal - Nato olive	2	Solder terminals	200A	500A	50mm <sup>2</sup>	24V	1	090 197 202
Socket with screw cover	Metal - Nato olive	2	Solder terminals	200A	500A	35/50mm <sup>2</sup>	24V	2	090 197 204

**Spare parts**

Contact bush for 35mm <sup>2</sup>	090 197 253
Contact bush for 35/50mm <sup>2</sup>	090 197 257
Complete cover cap	090 197 291

VG 96 917

VDA 72 593 A - Nato socket Yellow



Nato socket with yellow rubber cover

Plug type	Material	Poled	Connection	Switching current	Switching current short term operation (10 sec.)	Suitable for cable up to:	Operation voltage	Pos	Article No.
Socket with rubber cover	Metal	2	Solder terminals	200A	500A	50mm <sup>2</sup>	24V	1	090 197 224
Socket with rubber cover	Metal	2	Solder terminals	200A	500A	50mm <sup>2</sup>	24V	2	090 197 226

Spare parts

Contact bush for 35/50mm <sup>2</sup>	090 197 257
Rubber cover	090 197 294

Nato plug - 2 poled



Nato plug, olive - strain relief for cable

Plug type	Material	Poled	Connection	Switching current	Switching current short term operation (10sec.)	Suitable for cable up to:	Operation voltage	Article No.
Plug	Metal	2	Solder terminals	160A	400A	035 mm <sup>2</sup>	24V	090 197 302

Spare parts

Contact pin	090 197 356
-------------	-------------

### VG 96 917 - Nato plug



Nato plug with union nut, olive- strain relief for cable IP54

Plug type	Poles	Material	Connection	Switching current	Switching current short term operation (10sec.)	Suitable for cable up to:	Max Cable dia.	Voltage	Pos	Article No.
Plug	2	Metal	Terminals for soldering and crimp	135 A	245 A	35 mm <sup>2</sup>	12 mm	24V	1	<b>090 197 306</b>
Plug	2	Metal	Terminals for soldering and crimp	160 A	400 A	35 mm <sup>2</sup>	12 mm	24V	1	<b>090 197 306</b>
Plug	2	Rubberized/ Metal	Terminals for soldering and crimp	135 A	245 A	35 mm <sup>2</sup>	12 mm	24V	2	<b>090 197 308</b>
Plug	2	Metal	Terminals for soldering and crimp	168 A	350 A	50 mm <sup>2</sup>	15 mm	24V	3	<b>090 197 304</b>
Plug	2	Metal	Terminals for soldering and crimp	168 A	350 A	50 mm <sup>2</sup>	15 mm	24V	4	<b>090 197 310</b>



VG 96 917 C 001  
VDA 72 594 C



Plug type	Material	Suitable for plug:	Article No.
Coupling	Rubber	090 197 302	<b>090 197 362</b>

VG 96 917 - Nato socket



Nato socket, black with rubber cover  
Contacts Silvered

Plug type	Material	Poled	Connection	Suitable For cable up to:	Operation voltage	Article No.
Socket, black with rubber cover	Plastic	2	Crimping or soldering	35/50mm <sup>2</sup>	24V	<b>090 197 226</b>

**B VDA 72 594 - 2 poled**



Nato socket 70mm<sup>2</sup>, olive/black

Plug type	Poled	Material	Connection	Switching current	Switching current short term operation (10sec.)	Suitable for cable up to:	Operation voltage	Article No.
Socket	2	Metal	Crimp / Solder terminals	250 A	2.500 A	70 mm <sup>2</sup>	6-24V	<b>090 197 222</b>

**C VDA 72 594 - 2 poled**



Nato plug 70 mm<sup>2</sup>, black - Strain relief for cable

Plug type	Poled	Material	Connection	Switching current	Switching current short term operation (10sec.)	Suitable for cable up to:	Operation voltage	Article No.
Plug	2	Rubber	Solder terminals	250A	2.500 A	70 mm <sup>2</sup>	24V	<b>090 197 322</b>

VG 96 923 - 12 poled



Nato socket, olive

Plug type	IP Rating	Poled	Material	Connection	Contacts silvered	Operation voltage	Suitable for socket with article No.	Article No.
Socket		12	Metal	Solder terminals	✓	12/24V	--	<b>090 197 012</b>

VG 96 923 - 12 poled



Nato plug, olive/black - flexible hinge cover  
Mounted stop device and strain relief clamp

Plug type	Poled	Material	Connection	Contact pins Ø	Switching current	Operation voltage	Suitable for socket with Article No	Article No.
Plug	12	Rubber	Solder terminals	Ø 17,5 mm	15 A	12/24V	090 197 012	<b>090 197 112</b>



# COIL CABLES WITH PLUGS

2 & 5 POLED



VG 96 917, 2 poled



Pos 1



Pos 2

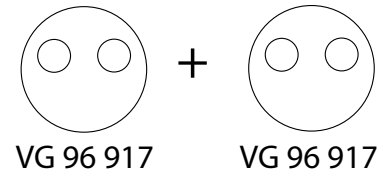
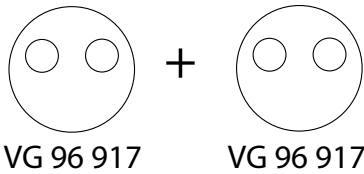

Coil cable with 2 pole rubberized plug with union nut  
Cold, warm and weather resistant  
Resistant to oil and chemicals

Approval	Plug type	Poled	Material cable	Working length	Coil Ø	Conductor cross section	Operation voltage	2 plugs with article No.	Pos	Article No.
VG 96 917 E001	Plug Black	2	Polyurethan	3500 mm	Ø65 mm	2 x 35 mm <sup>2</sup>	24V	090 197 308	1	<b>090 197 841</b>
VG 96 917 E001	Nato plug Green	2	Polyurethan	4.000 mm	Ø65 mm	2 x 35 mm <sup>2</sup>	24V	090 197 305	2	<b>090 197 844</b>

ISO 7638 -1, 5 poled

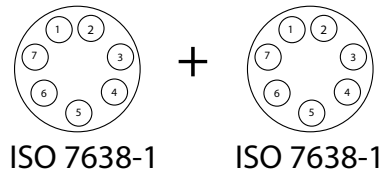

ABS coil cable with plugs

ISO Norm	Plugtype	Poled	Material cable	Working length	Coil Ø	Conductor cross section	Operation voltage	2 plugs with article No.	Article No.
7638-1	Plug	5	Polyurethan	4.000 mm	Ø 22 mm	2x4,0 + 3x1,5 mm <sup>2</sup>	24V	090 190 001	<b>090 195 440</b>

# COIL CABLES WITH PLUGS

7 POLED



### ISO 1185 N-type (24V)



Coil cable with connectors 24V N-Type

ISO Norm	Plugtype	Poled	Material Cable	Working length	Coils	Conductor cross section	Operation voltage	Pos	Article No.
1185	Plug Alu	7	Polyurethan	3.500 mm	Ø19 mm	6x1 mm <sup>2</sup> + 1x1,5 mm <sup>2</sup>	24V	1	<b>090 183 374</b>
1185	Plug, moulded plastic	7	Polyurethan	3.500 mm	Ø19 mm	6x1 mm <sup>2</sup> + 1x1,5 mm <sup>2</sup>	24V	2	<b>090 182 374</b>
1185	Plug moulded plastic	7	Polyurethan	4.000 mm	Ø19 mm	6x1 mm <sup>2</sup> + 1x1,5 mm <sup>2</sup>	24V	2	<b>090 182 376</b>
1185	Plug moulded plastic	7	Polyurethan	4.500 mm	Ø19 mm	6x1 mm <sup>2</sup> + 1x1,5 mm <sup>2</sup>	24V	2	<b>090 182 378</b>

### ISO 1185 + ISO 1724



Coil cable with plastic connectors

ISO Norm	Plugtype	Poled	Material Cable	Working length	Coil Ø	Conductor cross section	Operation voltage	Article No.
1185+1724	Plug plastic	7	Polyurethan	4.000 mm	Ø 19 mm	6x1mm <sup>2</sup> + 1x1,5mm <sup>2</sup>	12/24V	<b>090 182 370</b>



ISO 1724 (12V)



Coil cable with moulded plastic connectors

ISO Norm	Plugtype	Poled	Material Cable	Working length	Coil Ø	Conductor cross section	Operation voltage	Pos	Article No.
1724	Plug	7	Polyurethan	1.500 mm	Ø 35 mm	6x1mm <sup>2</sup> + 1x1,5mm <sup>2</sup>	12V	1	<b>090 180 165</b>
1724	Plug	7	Polyurethan	3.500 mm	Ø 35 mm	6x1mm <sup>2</sup> + 1x1,5mm <sup>2</sup>	12V	2	<b>090 182 365</b>
1724	Plug Alu	7	Polyurethan	4.000 mm	Ø 19 mm	6x1mm <sup>2</sup> + 1x1,5mm <sup>2</sup>	12V	3	<b>090 183 312</b>

ISO 3731 - S-Type (24V)



Coil cable with aluminium connectors S-Type

ISO Norm	Plugtype	Poled	Material Cable	Working length	Coil Ø	Conductor cross section	Operation voltage	Article No.
3731	Plug	7	Polyurethan	3.500 mm	Ø 40 mm	6x1,0 mm <sup>2</sup> + 1x1,5mm <sup>2</sup>	24V	<b>090 183 377</b>

ISO 3731 - S-Type (24V)

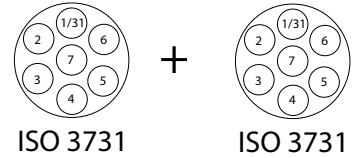

Coil cable with yellow moulded plastic connectors S-Type  
Cold, heat and weather protected. Resistant to oil and chemicals

ISO Norm	Plugtype	Poled	Material Cable	Working length	Coil Ø	Conductor cross section	Operation voltage	Article No.
3731	Plug, moulded plastic	7	Polyurethan	3.500 mm	Ø 19 mm	6x1,0mm <sup>2</sup> + 1x1,5mm <sup>2</sup>	24V	<b>090 183 379</b>
3731	Plug, moulded plastic	7	Polyurethan	4.000 mm	Ø 19 mm	6x1,0mm <sup>2</sup> + 1x1,5mm <sup>2</sup>	24V	<b>090 183 380</b>

ISO 7638 -1 - EBS (24V)

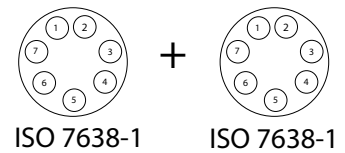

EBS coil cable with socket

ISO Norm	Plugtype	Poled	Material Cable	Working length	Coil Ø	Conductor cross section	Operation voltage	2 socket with article No.	Article No.
7638-1	Socket	7	Polyurethan	3500 mm	Ø 22 mm	2x1,5+2x4,0+3x1,5 mm <sup>2</sup>	24V	090 190 071	<b>090 195 835</b>
7638-1	Socket	7	Polyurethan	4.000 mm	Ø 22 mm	2x1,5+2x4,0+3x1,5 mm <sup>2</sup>	24V	090 190 071	<b>090 195 840</b>

# COIL CABLES WITH PLUGS

13 & 15 poled



ISO 11446 - 13 poled (12V)

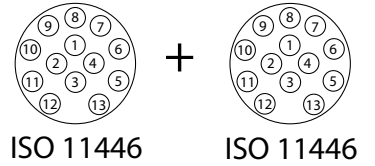

Coil cable with plastic connectors

ISO Norm	Plug type	Poled	Material Cable	Working length	Coil Ø	Conductor cross section	Operation voltage	Article No.
11446	Plug	13	Polyurethan	3500 mm	Ø 60 mm	10x1,5mm <sup>2</sup> + 3x2,5mm <sup>2</sup>	12V	<b>090 163 702</b>

ISO 12098 / 4141 - 15 poled (24V)

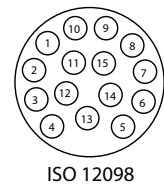

ISO	Plugtype	Poled	Material Cable	Working length	Coils Ø	Conductor cross section	Operation voltage	Article No.
12098	Socket	15	Polyurethan	4.000 mm	Ø 66 mm	12x1,5kv+3x2,5 mm <sup>2</sup>	24V	<b>090 165 813</b>

# COIL CABLES WITHOUT PLUGS

---



### Coil cables without plugs



Colour		Conductor cross section	Working length	Outer-Coil Ø	L1 (un-coiled length - the ends of the cable)	L2 (un-coiled length - the ends of the cable)	Material	Article No.
Black		2 x 0,75 mm <sup>2</sup>	3.000 mm	Ø25	145 mm	145 mm	Polyurethan	090 179 207
Black		3 x 0,75 mm <sup>2</sup>	3.000 mm	Ø25	220 mm	220 mm	Polyurethan	090 179 307
Black		4 x 0,75 mm <sup>2</sup>	3.000 mm	Ø25	200 mm	2.000 mm	Polyurethan	090 179 408
Black		5 x 0,75 mm <sup>2</sup>	3.500 mm	Ø25	2.000 mm	200 mm	Polyurethan	090 179 507
Black		2 x 1,0 mm <sup>2</sup>	4.000 mm	Ø25	130 mm	130 mm	Polyurethan	090 179 212
Black		2 x 1,5 mm <sup>2</sup>	3.000 mm	Ø25	130 mm	130 mm	Polyurethan	090 179 215
Amber		2 x 1,5 mm <sup>2</sup>	3.000 mm	Ø35	130 mm	130 mm	Polyurethan	090 179 216
Black		5 x 1,5mm <sup>2</sup>	3.500 mm	Ø40	2.000 mm	200 mm	Polyurethan	090 179 516
Black		7 x 1,5 mm <sup>2</sup>	4.000 mm	Ø95	200 mm	200 mm	Polyurethan	090 180 400
Black		7 x 0,75 + 1 x 1,5 mm <sup>2</sup>	5.500 mm	Ø40	500 mm	500 mm	Polyurethan	090 179 807
Black		6 x 1 + 1 x 2,5 mm <sup>2</sup>	4.500 mm	Ø40	300 mm	300 mm	Polyurethan	090 182 452
Black		6 x 1,0 + 1 x 2,0 mm <sup>2</sup>	3.500 mm	Ø40	180 mm	180 mm	Polyurethan	090 182 350
Black		6 x 1 + 1 x 2 mm <sup>2</sup>	4.000 mm	Ø40	180 mm	180 mm	Polyurethan	090 182 400
Black		8 x 1+1 x 2 mm <sup>2</sup>	3.500 mm	Ø48	1.500 mm	210 mm	Polyurethan	090 179 815
Black		10 x 1,5 + 3 x 2,5 mm <sup>2</sup>	3.000 mm	Ø65	230 mm	230 mm	Polyurethan	090 179 963
Black		12 x 1,5+3 x 2,5 mm <sup>2</sup>	4.000 mm	Ø65	150 mm	150 mm	Polyurethan	090 165 806
Black		1 x 35 mm <sup>2</sup>	4.000 mm	Ø60	200 mm	200 mm	Polyurethan	099 898 835
Red		1 x 35 mm <sup>2</sup>	4.000 mm	Ø60	200 mm	200 mm	Polyurethan	099 898 836
Black/Red		2 x 35 mm <sup>2</sup>	4.000 mm	Ø60	200 mm	200 mm	Polyurethan	099 898 837
Black/Red		2 x 35 mm <sup>2</sup>	3.500 mm	Ø60	200 mm	200 mm	Polyurethan	099 898 838

# ADAPTER & CONNECTION CABLES

---



Adapter - 15 poled to 7 poled



Pos 1



Pos 2

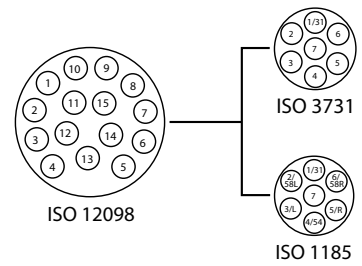

15 pole plug to 24N/ 24S 7 pole plug

ISO Norm	Type	Poled	Material	Plug for socket	Working length	Operation voltage	Pos	Article No.
12098 - 1185/3731	Adapter	15 > 2x7 24N/24S	Plastic	7 poled 24N/24S	--	12/24V	1	<b>090 165 840</b>
12098 - 1185/3731	Adapter	15 > 2x7 24N/24S	Plastic	7 poled 24N/24S	--	12/24V	2	<b>090 165 845</b>



12098 to 1185/3731 - 15 poled > 2x7 poled

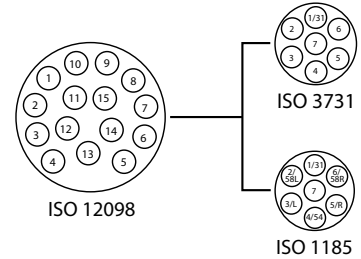

Connection diagram

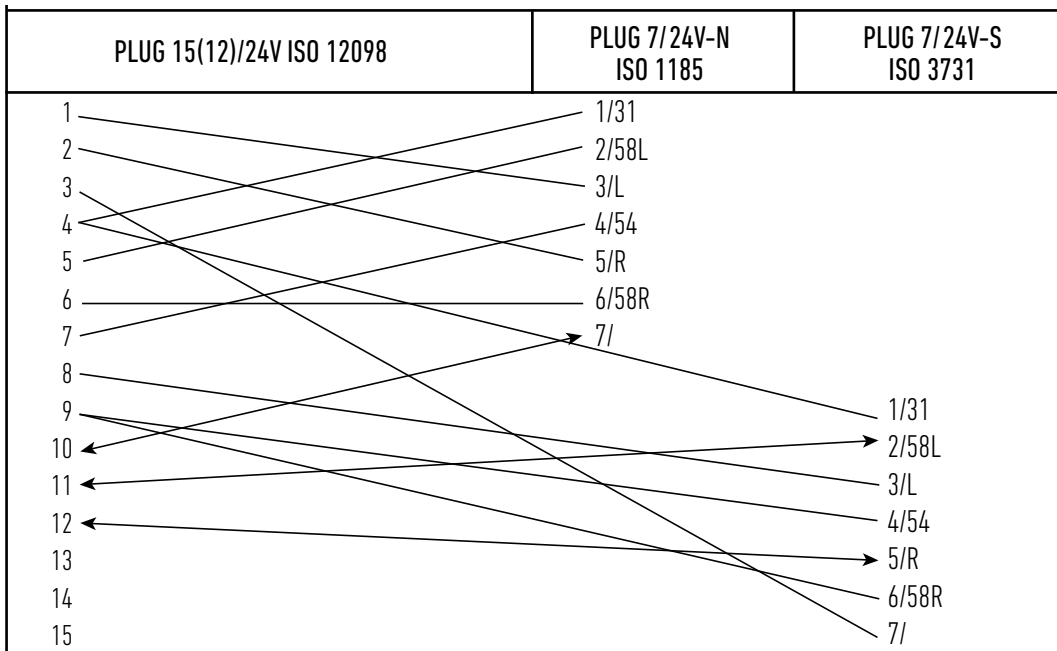

Coil cable from 15-pole socket to 24N/24S 7-pole plug  
Cold, heat and weather protected. Resistant to oil and chemicals

ISO Norm	Application	Plug type	Poled	Material Cable	Working length	Coilt	Cross section conductor	Operation voltage	Article No.
12098 to 1185/3731	Mercedes	Socket overmoulded	15 > 2x7 24N/24S	Polyurethan	4.000 mm	Ø 14 mm	6x1,0 mm <sup>2</sup> + 1x1,5 mm <sup>2</sup>	24V	090 165 830
12098 to 1185/3731	Iveco Volvo	Socket overmoulded	15 > 2x7 24N/24S	Polyurethan	2 x 4.500 mm	Ø 19 mm	6x1,0 mm <sup>2</sup> + 1x1,5 mm <sup>2</sup>	24V	090 165 834

12098 to 1185/3731 Coil cable - 15 poled > 2x7 poled

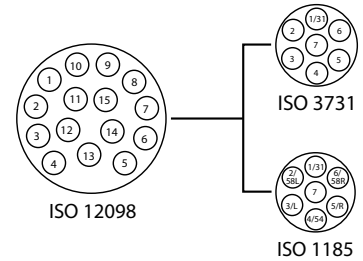

Connection diagram

PLUG 15(12)/24V	PLUG 7/24V-N		PLUG 7/24V-S	
	Colour	Number	Colour	Number
1	White	1/31		
2	Black	2/58L		
3	Yellow	3/L		
4	Red	4/54		
5	Green	5/R		
6	Brown	6/58R		
7	Blue	7/		
8			White	1/31
9			Black	2/58L
10			Yellow	3/L
11			Red	4/54
12			Green	5/R
13			Brown	6/58R
14			Blue	7/
15				

Coil cable from 15-pole socket to 24N/ 24S 7-pole plug  
Cold, heat and weather protected. Resistant to oil and chemicals

ISO Norm	Application	Plugtype	Poled	Working length	Coil	Cross section conductor	Operation voltage	Article No.
12098 to 1185/3731		Socket overmoulded	15 > 2x7 24N/24S	2 x 4.000 mm	Ø 19 mm	6x1,0 mm <sup>2</sup> + 1x1,5 mm <sup>2</sup>	24V	090 165 826
12098 to 1185/3731	MB Actros Scania	Socket overmoulded	15 > 2x7 24N/24S	2 x 4.500 mm	Ø 19 mm	6x1,0 mm <sup>2</sup> + 1x1,5 mm <sup>2</sup>	24V	090 165 836

12098 to 1185/3731 Coil cable - 15 poled > 2x7 poled

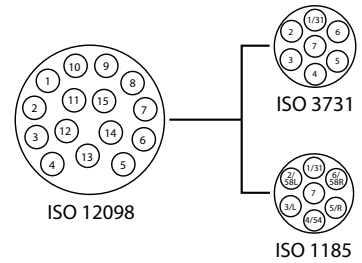

Connection diagram

PLUG 15(12)/24V	PLUG 7/24V-N		PLUG 7/24V-S	
	Colour	Number	Colour	Number
1	White	1/31		
2	Black	2/58L		
3	Yellow	3/L		
4	Red	4/54		
5	Green	5/R		
6	Brown	6/58R		
7	Blue	7/		
8			White	1/31
9			Black	2/58L
10			Yellow	3/L
11			Red	4/54
12			Green	5/R
13			Brown	6/58R
14			Blue	7/
15				

Coil cable from 15-pole socket to 24N/ 24S 7-pole plug  
Cold, heat and weather protected. Resistant to oil and chemicals

ISO Norm	Plugtype	Poled	Working length	Coil	Cross section conductor	Operation voltage	Article No.
12098 to 1185/3731	Alu. socket	15 > 2x7 24N/24S	4.000 mm	Ø 19 mm	6x1,0 mm <sup>2</sup> + 1x1,5 mm <sup>2</sup>	24V	<b>090 165 822</b>

12098 to 1185 Coil cable - 15 poled > 7 poled

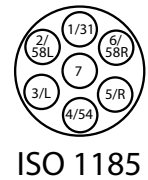
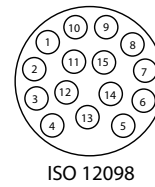

Connection diagram

PLUG 15/24V	PLUG 7/24V-N
1	1
2	2
3	3
4	4
5	5
6	6
7	7
8	8
9	9
10	10
11	11
12	12
13	13
14	14
15	15

Coil cable from 15-pole socket to 24N/ 24S 7-pole plug  
Cold, heat and weather protected. Resistant to oil and chemicals

ISO Norm	Plugtype	Poled	Working length	Coil	Cross section conductor	Operation voltage	Article No.
12098 to 1185	Socket overmoulded	15 > 7 24N	4.500 mm	Ø 19 mm	6x1,0 mm <sup>2</sup> + 1x1,5 mm <sup>2</sup>	24V	<b>090 165 828</b>

ISO 1185 > ISO 1724 or ISO 1185 > ISO 11446- Adapter with converter - 24V > 12V



Adapter from 13-pin socket to 7-pin plug

ISO Norm	Type	Poled	Material	Operation voltage	Consumption	Pos	Article No.
ISO 11446 > ISO 1724	Adapter	13-pin socket 7-pin plug	Plastic	12V	20 A	1	<b>090 163 815</b>
ISO 11446 > ISO 1724	Adapter	13-pin socket 7-pin plug	Plastic	12V	20 A	2	<b>090 163 818</b>
ISO 1724 > ISO 11446	Adapter	13-pin socket 7-pin plug	Plastic	12V	20 A	3	<b>090 163 819</b>



Converter to supply 12V trailer from a 24V vehicle. Only for trailers with bulb light.

Working temperatur:                      -40 ° to +75 °  
 Dimension:                                      75 mm x 190 mm  
 Approval:    E110R

ISO Norm	Type	Poled	Material	Operation voltage	Consumption	Pos	Article No.
ISO 1185 > ISO 1724	Adapter 7 > 7 poled	Plug: 24V, 7 poled N plug ISO 1185 Socket: 12V, 7 poled ISO 1724	Plastic	12V	250W	1	<b>090 163 842</b>
ISO 1185 > ISO 11446	Adapter 7 > 13 poled	Plug: 24V, 7 poled N plug, ISO 1185 Socket: 12V, 7 poled ISO 11446	Plastic	12V	250W	2	<b>090 163 843</b>

ISO 7638 - EBS connection cable - 7 poled



Pos 1



Pos 2

Double insulated. Max. 50V  
Oil resistant  
Operation temperature: -40° - +80°

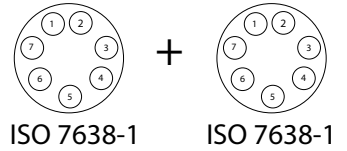

ISO Norm	Wire colours	Material	Conductor cross section	Cable length	Unit	Operation voltage	Pos	Article No.
7638-1	5 x 1,5 mm <sup>2</sup> : Yellow, brown, white, white/green, white/brown. 2 x 4 mm <sup>2</sup> : Red, black	Polyurethan	5 x 1,5 + 2 x 4,0 mm <sup>2</sup>	50 m	Roll	24V	1	099 897 274
7638-1	5 x 1,5 mm <sup>2</sup> : Yellow, brown, white, white/green, white/brown. 2 x 4 mm <sup>2</sup> : Red, black	Polyurethan	5 x 1,5 + 2 x 4,0 mm <sup>2</sup>	400 m	Roll	24V	2	099 897 276

EBS connection cable - 7 poled



Pos 1



Pos 2



Pos 4

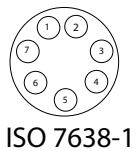

EBS Connecting cables with sockets

ISO Norm	Plugtype	Poled	Material Cable	Working length	Conductor cross section	Operation voltage	1 socket with article no.	Pos	Article No.
7638-1	Socket	7	Polyurethan	8 m	5x1,5 mm <sup>2</sup> + 2x4,0 mm <sup>2</sup>	24V	090 190 075	1	090 193 782
7638-1	Plug	7	Polyurethan	10 m	5x1,5 mm <sup>2</sup> + 2x4,0 mm <sup>2</sup>	24V	090 190 071	2	090 191 800

Spare parts

Mounting angle , Zink- plated steel	4	090 198 918
-------------------------------------	---	-------------

# AIR BRAKE TUBE & COILS

---



## Air brake tube



ISO norm	Material	Colour	Cross section conductor	Meter	Article No.
DIN 74324/73378, ISO 7628	PA12	Black	5 x 1,00 mm <sup>2</sup>	25 m roll	<b>028 950 005</b>
DIN 74324/73378, ISO 7628	PA12	Black	6 x 1,00 mm <sup>2</sup>	25 m roll	<b>028 960 006</b>
DIN 74324/73378, ISO 7628	PA12	Black	6 x 1,00 mm <sup>2</sup>	100 m roll	<b>028 960 066</b>
DIN 74324/73378, ISO 7628	PA12	Black	8 x 1,00 mm <sup>2</sup>	25 m roll	<b>028 960 008</b>
DIN 74324/73378, ISO 7628	PA12	Black	8 x 1,00 mm <sup>2</sup>	100 m roll	<b>028 960 068</b>
DIN 74324/73378, ISO 7628	PA12	Black	10 x 1,00 mm <sup>2</sup>	25 m roll	<b>028 960 010</b>
DIN 74324/73378, ISO 7628	PA12	Black	10 x 1,00 mm <sup>2</sup>	200 m roll	<b>028 950 020</b>
DIN 74324/73378, ISO 7628	PA12	Black	10 x 1,25 mm <sup>2</sup>	25 m roll	<b>028 960 011</b>
DIN 74324/73378, ISO 7628	PA12	Black	9 x 1,5 mm <sup>2</sup>	25 m roll	<b>028 950 029</b>
DIN 74324/73378, ISO 7628	PA12	Black	10 x 1,5 mm <sup>2</sup>	25 m roll	<b>028 960 009</b>
DIN 74324/73378, ISO 7628	PA12	Black	10 x 1,5 mm <sup>2</sup>	100 m roll	<b>028 950 060</b>
DIN 74324/73378, ISO 7628	PA12	Black	11 x 1,5 mm <sup>2</sup>	25 m roll	<b>028 950 021</b>
DIN 74324/73378, ISO 7628	PA12	Black	12 x 1,5 mm <sup>2</sup>	25 m roll	<b>028 960 012</b>
DIN 74324/73378, ISO 7628	PA12	Black	12 x 1,5 mm <sup>2</sup>	100 m roll	<b>028 950 062</b>
DIN 74324/73378, ISO 7628	PA12	Black	12 x 1,5 mm <sup>2</sup>	200 m roll	<b>028 950 072</b>
DIN 74324/73378, ISO 7628	PA12	Black	15 x 1,5 mm <sup>2</sup>	25 m roll	<b>028 960 015</b>
DIN 74324/73378, ISO 7628	PA12	Black	15 x 1,5 mm <sup>2</sup>	100 m roll	<b>028 960 065</b>
DIN 74324/73378, ISO 7628	PA12	Black	16 x 2,00 mm <sup>2</sup>	25 m roll	<b>028 960 016</b>
DIN 74324/73378, ISO 7628	PA12	Black	18 x 2,00 mm <sup>2</sup>	25 m roll	<b>028 960 018</b>



Air brake coil



ISO norm: DIN 74324/74323/73378 – ISO 7375

Material	Working length	Number of coils	Outer Coil Ø mm	Connection	Tube colour	Anti bend color	Article No.
PA12	4.000 mm	22	Ø 75 mm	M16x1,5 mm	Double Red/Yellow	Red/yellow	028 920 172
PA12	4.500 mm	24	Ø 75 mm	M16x1,5 mm	Yellow	Metal	028 920 173
PA12	4.500 mm	24	Ø 75 mm	M16x1,5 mm	Red	Metal	028 920 175
PA12	4.500 mm	24	Ø 75 mm	M22x1,5 mm	Red	Metal	028 920 176
PA12	4.500 mm	24	Ø 75 mm	M16x1,5 mm	Black/yellow	Yellow	028 920 177
PA12	4.500 mm	24	Ø 75 mm	M16x1,5 mm	Black/red	Red	028 920 178
PA12	4.000 mm	22	Ø 75 mm	M18 x 1,5 mm	Red	Red	028 920 082
PA12	4.000 mm	22	Ø 75 mm	M18 x 1,5 mm	Yellow	Yellow	028 920 087
PA12	4.000 mm	22	Ø 75 mm	M18x1,5/M16x1,5 mm	Black/yellow	Yellow	028 920 088
PA12	4.000 mm	22	Ø 75 mm	M18x1,5/M16x1,5 mm	Red/Yellow	Metal	028 920 090
PA12	4.500 mm	22	Ø 75 mm	M18x1,5/M16x1,5 mm	Yellow	Yellow	028 920 089
PA12	4.500 mm	22	Ø 75 mm	M18 x1,5/M16 x 1,5 mm	Red	Metal	028 920 081
PA12	5.500 mm	22	Ø 115 mm	M16x1,5 mm	Yellow	Metal	028 920 161
PA12	5.500 mm	22	Ø 115 mm	M16x1,5 mm	Red	Metal	028 920 165
PA12	5.500 mm	22	Ø 115 mm	M18x1,5 mm	Black/yellow	Yellow	028 920 169
PA12	5.500 mm	22	Ø 115 mm	M18x1,5 mm	Black/yellow	Red	028 920 170
PA12	6.500 mm	27	Ø 115 mm	M22x1,5 mm	Yellow	Metal	028 920 163
PA12	6.500 mm	27	Ø 115 mm	M22x1,5 mm	Red	Metal	028 920 167
PA12	4.500 mm	24	Ø 75 mm	M22x1,5 mm	Yellow	Metal	028 920 174
PA12	1.0000 mm	22	Ø 160 mm	M22x1,5 mm	Black	Yellow	028 920 160
PA12	10.000 mm	21	Ø 115 mm	M22x1,5 mm	Red	Metal	028 920 164

## Spare parts for air brake coil



Pos 1



Pos 2



Pos 3



Pos 4

Type	Size	Suitable for air brake coil with Article No.	Pos	Article No.
Thread connection for air brake coils	M18x1,5/M16x1,5	028920081/082/083/087/088/089/090	1	<b>028 929 805</b>
Thread connection for air brake coils	M18x1,5/M16x1,6	028920081/082/083/087/088/089/090	2	<b>028 929 810</b>
Thread connection for air brake coils	M18x1,5/M16x1,7	028920081/082/083/087/088/089/090	3	<b>028 929 815</b>
Thread connection for air brake coils	M18x1,5/M16x1,8	028920081/082/083/087/088/089/090	4	<b>028 929 820</b>

# JUNCTION BOXES

---

In the contribution boxes the brake-, position-, side marker- and out-end marker lights only are connected to a passive working electronic devise. Error functions are thus not – with the present technic – shown in a trustworthy way on the dashboard. In order to ensure an outage control of the indicators being is according with the EU legislation, it is necessary to install a LED control box (please see page 89).



Universal Junction box

Application/ Description

Article No.

**Junction box**  
**Housing of black polycarbonate**  
**IP Rating: IP69K**

**Low version - Connections:**

- Connection: 1 x Cable gland with grommet Ø11-13 mm
- 1 x Cable gland with grommet Ø7-11 mm
- 2 x Cable gland with grommet Ø4-6 mm
- 4 x Cable gland with grommet 2 x Ø5,5 mm

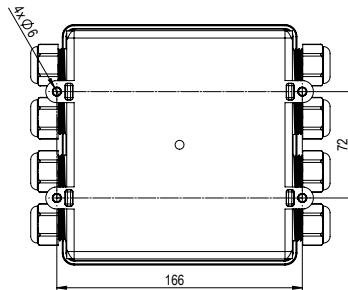
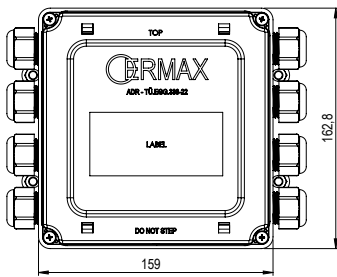
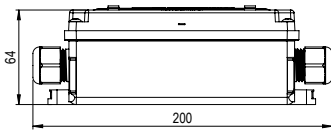

099 864 100

**High version - Connections:**

- Connection: 1 x Cable gland with grommet Ø11-13 mm
- 4 x Cable gland with grommet Ø7-11 mm
- 8 x Cable gland with grommet Ø4-6 mm
- 1 x Cable gland with grommet 2 x Ø5,5 mm

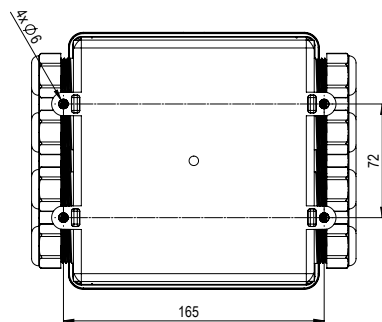
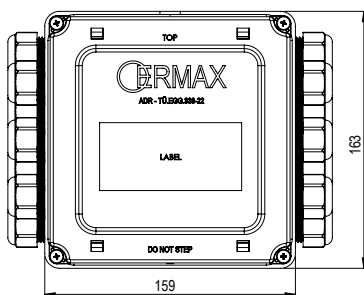
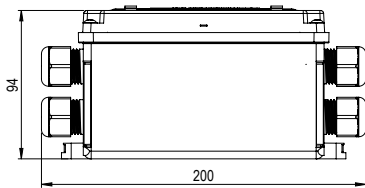

099 864 500

Rear connection Junction box

Application/ Description

Article No.

**Junction box**  
**Housing of black polycarbonate**  
**IP Rating: IP69K**

**Low version - Connections:**

Inlet: 15-polige Ermax Steckdose, 500 mm Kabel

- Connection:
- 1 x 7 pin AMP socket for right tail light
  - 1 x 7 pin AMP socket for left tail light
  - 1 x 2 pin Super Seal socket for right position light
  - 1 x 2 pin Super Seal socket for left position light
  - 1 x 2 pin Super Seal socket for reverse light
  - 1 x 2 pin Super Seal socket for rear fog light
  - 1 x Cable gland with grommet 2 x Ø5,5 mm

**High version - Connections:**

Inlet: 15-polige Ermax Steckdose, 500 mm Kabel

- Connection:
- 1 x 7 pin AMP socket for right tail light
  - 1 x 7 pin AMP socket for left tail light
  - 1 x 2 pin Super Seal socket for right position light
  - 1 x 2 pin Super Seal socket for left position light
  - 1 x 2 pin Super Seal socket for reverse light
  - 1 x 2 pin Super Seal socket for rear fog light
  - 1 x 2 pin Super Seal socket for stop light
  - 1 x 2 pin Super Seal socket for AUX 3
  - 1 x Cable gland with grommet 2 x Ø5,5 mm
  - 2 x Cable gland with grommet Ø4-6 mm
  - 2 x Cable gland with grommet Ø7-10 mm

099 864 110

099 864 510

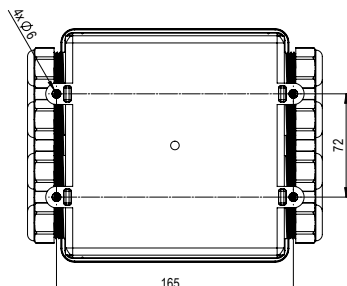
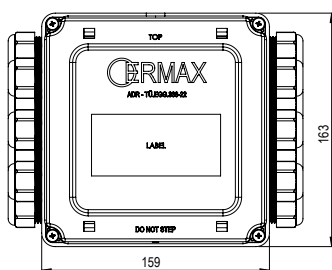
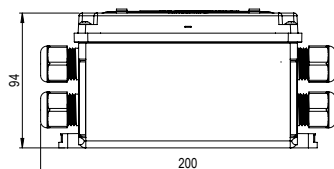
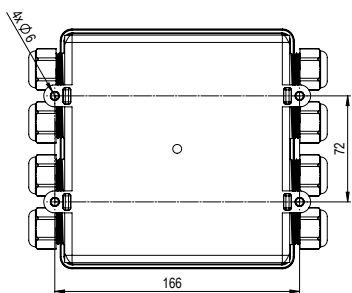
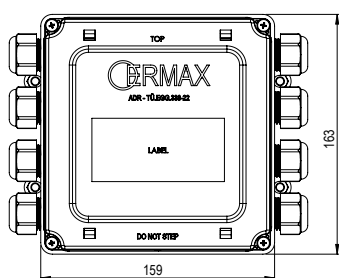
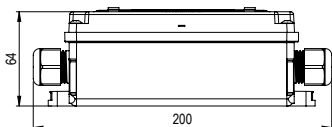

Universal box

Application/ Description

Article No.

Universal box with clamp straps and plug cartridge  
 Housing of black polycarbonate  
 IP Rating: IP69K

High version - Connections:

Additional inlets/outlets:

- 1 x Cable gland with grommet Ø11-13 mm
- 6 x Cable gland with grommet Ø4-6 mm
- 7 x Cable gland with grommet 2 x Ø5,5 mm

099 864 651

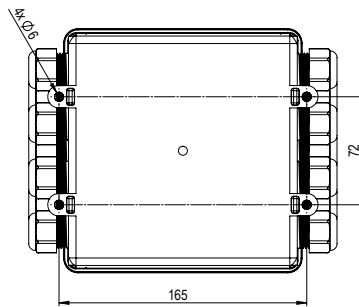
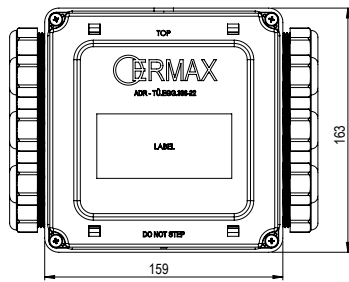
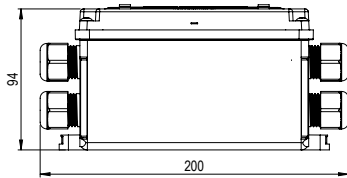

Spare parts - Junctions box

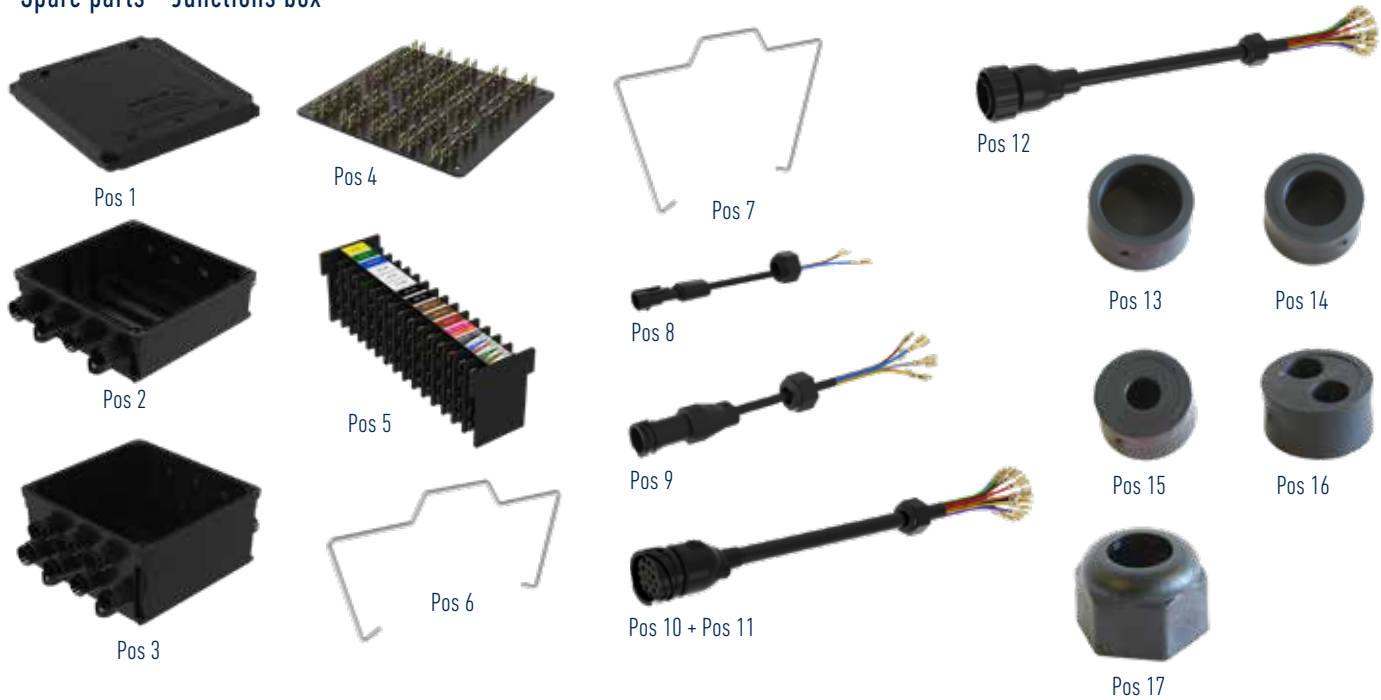

Spareparts / Accessories Ermax Junction box

Cover for junction box. Incl. Screws. Suitable for both the low and high version of the junction box. Measurements ( H x W x L): 18 x 153 x 157 mm	1	099 110 800
Cover for junction box. Incl. Screws. Suitable for both the low and high version of the junction box. Measurements ( H x W x L): 18 x 153 x 157 mm	2	099 110 801
Junction box, high version - without cover and cable glands. 14 cable inlets ( without nuts and rubber grommets) 5 mounting grooves for self-tapping screws in the bottom.	3	099 110 802
Terminal board for junction box with 104 terminals. Suitable for both low and high version of the junction box. Incl. screws for installation.	4	099 110 803
Terminal cartridge for junction box, removable with 120 terminals.	5	099 110 804
Locking brace for junction box, low version. The locking brace is used to keep the cover in place on the junction box. 2 pcs per box is needed. Material: Stainless steel.	6	099 110 805
Locking brace for junction box, high version. The locking brace is used to keep the cover in place on the junction box. 2 pcs per box is needed. Material: Stainless steel.	7	099 110 806
Connection cable 300mm with Super Seal socket for junction box. Mounted with grommet 2 x Ø5,5 mm and nut for junction box. 200 mm stripped wire with blade receptacles.	8	099 110 820
Connection cable 300 mm with 7 pole AMP socket for junction box. Mounted with grommet 2 x Ø4-6 mm and nut for junction box. 200 mm stripped wire with blade receptacles.	9	099 110 870
Connection cable 700 mm with 15 pole Ermax socket for junction box. Mounted with grommet 2 x Ø11-13 mm and nut for junction box. 200 mm stripped wire with blade receptacles.	10	099 110 880
Connection cable 1700 mm with 15 pole Ermax socket for junction box. Mounted with grommet 2 x Ø11-13 mm and nut for junction box. 200 mm stripped wire with blade receptacles.	11	099 110 881
Connection cable 700 mm with 15 pole Ermax plug for junction box. Mounted with grommet 2 x Ø11-13 mm and nut for junction box. 200 mm stripped wire with blade receptacles.	12	099 110 885
Rubber sealing for cablegland housing in junction box Ø16/Ø13-11 mm	13	099 110 207
Rubber sealing for cablegland housing in junction box, Ø16/Ø10-7 mm	14	099 110 208
Rubber sealing for cablegland housing in junction box, Ø16/Ø6-4 mm	15	099 110 209
Rubber sealing for cablegland housing in junction box, Ø16/2 xØ5,5 mm	16	099 110 210
Nut for cablegland housing	17	099 110 206

## Spare parts Junction box (Old version - Generation 1)



Pos. 1



Pos. 2

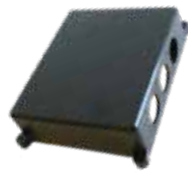

Pos. 3



Pos. 4



Pos. 5



Pos. 6



Pos. 7



Pos. 8



Pos. 9



Pos. 10



Pos.11



Pos. 12



Pos. 13



Pos. 14

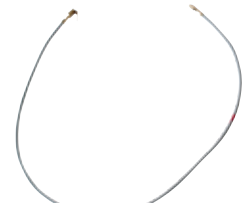

Pos. 15

## Spare parts / Accessories

Junctionbox w/o cover and connections. 8 x connections. 158 x 143 mm	1	099 110 200
Cover for junctionbox, low version, 158 x 143 x 18 mm	2	099 110 201
Cover for junctionbox, high version, 158 x 143 x 45 mm	3	099 110 202
Gasket for connections in junctionbox	4	099 110 203
Lock ring for connections in junctionbox	5	099 110 204
Housing for cable gland M22/2,0 in junctionbox	6	099 110 205
Nut for cable gland housing in junctionbox	7	099 110 206
Rubber blind for cable gland in junctionbox, Ø16/Ø11-13 mm	8	099 110 207
Rubber blind for cable gland in junctionbox, Ø16/Ø7-11 mm	9	099 110 208
Rubber seal, for cable diameter Ø4-6mm	10	099 110 209
Rubberblind for cable gland housing in junctionbox Ø16/2 x Ø5,5 mm	11	099 110 210
Super Seal socket for junctionbox. Black and white (-) wire	12	099 110 211
Plug AMP 1,5 7-poled	13	099 110 212
Resistor 24V for direction indicator LxWxH: 75 x 61 x 20 mm	14	098 292 358
Heating cable (resistor) 24V with cable shoe Length: 545 mm	15	093 865 125



### Junction box



Pos 1



Pos 2

IP Rating	Connection	L x B x H	Fastening	Hole distance	Plastic housing	Pos	Article No.
IP54	6 x 2 screw connection 4 rubber cable exits cable Ø max. 10,0 mm	125 x 73 x 35 mm			✓	1	099 865 075
IP54	12 x 2 screw terminals 6,3 x 0,8 mm	147 x 74 x 37 mm	2 holes Ø4,8 mm	30 mm	✓	2	099 862 012

### Junction box



Pos 1



Pos 2



Pos 3

#### Plastic housing

IP Rating	Connection	L x B x H	Fastening	Out/Input	Pos	Article No.
IP56	8 x 6 fold blade terminals 6,3 x 0,8 mm	155 x 100 x 50 mm	Hole Ø5,5 mm	4 exits (2 x M20 x 1,5 + 2 x M16 x 1,5)	1	099 868 249
IP56	8 x 6 fold blade terminals 6,3 x 0,8 mm	155 x 130 x 50 mm	Hole Ø5,5 mm	6 exits (2 x M20 x 1,5 + 4 x M16 x 1,5)	2	099 868 269
IP56	13 x 6 fold blade terminals 6,3 x 0,8 mm	245 x 170 x 70 mm	Hole Ø5,5 mm	7 exits (1 x M25 x 1,5 + 4 x M20 x 1,5 + 2 x M16 x 1,5)	3	099 868 314

#### Spare parts

Cable connector	099 868 291
Cable connector	099 868 392

Cable gland

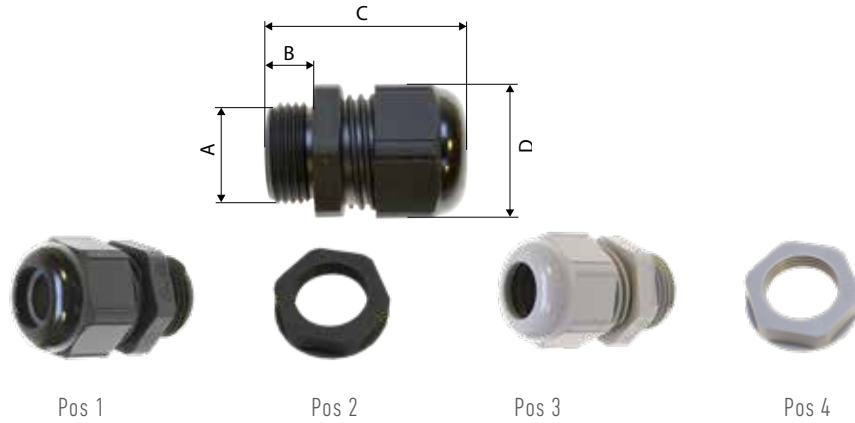

Cable gland without nut  
UV-resistant

IP Rating	A	B	C	D	Cable Ø	Working temperature	Black polyamide	Grey polyamide	Pos	Article No.
IP69K	M 16 X 1,5	8 mm	34 mm	19 mm	4,5-10 mm	-40°C - +100°C	✓		1	099 866 116
IP69K	M 20 X 1,5	9 mm	37 mm	25 mm	7-13 mm	-40°C - +100°C	✓		1	099 866 120
IP69K	M 25 X 1,5	10 mm	40 mm	30 mm	9-17 mm	-40°C - +100°C	✓		1	099 866 125
IP69K	M 32 X 1,5	10 mm	47 mm	36 mm	11-21 mm	-40°C - +100°C	✓		1	099 866 132
IP69K	M 12 X 1,5	8 mm	30 mm	15 mm	3,5-7 mm	-40°C - +100°C		✓	3	099 866 312
IP69K	M 16 X 1,5	8 mm	34 mm	19 mm	4,5-10 mm	-40°C - +100°C		✓	3	099 866 316
IP69K	M 20 X 1,5	9 mm	37 mm	25 mm	7-13 mm	-40°C - +100°C		✓	3	099 866 320
IP69K	M 25 X 1,5	10 mm	40 mm	30 mm	9-17 mm	-40°C - +100°C		✓	3	099 866 325
IP69K	M 32 X 1,5	10 mm	47 mm	36 mm	11-21 mm	-40°C - +100°C		✓	3	099 866 332

Spare parts

Nut for cable gland M 16 X 1,5	2	099 866 216
Nut for cable gland M 20 X 1,5	2	099 866 220
Nut for cable gland M 25 X 1,5	2	099 866 225
Nut for cable gland M 32 X 1,5	2	099 866 232
Nut for cable gland M 12 X 1,5	4	099 866 412
Nut for cable gland M 16 X 1,5	4	099 866 416
Nut for cable gland M 20 X 1,5	4	099 866 420
Nut for cable gland M 25 X 1,5	4	099 866 425
Nut for cable gland M 32 X 1,5	4	099 866 432

Cable gland



Cable gland  
Break and impact-resistant. Acid resistant

IP Rating	A	B	C	D	Cable Ø	Working temperature	With nut	Grey nylon PA6	Pos	Article No.
IP54	PG7 (12,5 mm)	6,5 mm	25 mm	13 mm	3,5-6 mm	-30°C - +120°C	✓	✓	1	099 868 407
IP54	PG9 (15,2 mm)	8 mm	28,4 mm	17 mm	6-10 mm	-30°C - +120°C	✓	✓	2	099 868 410
IP54	PG11 (18,6 mm)	9 mm	31 mm	20 mm	6,8-10,5 mm	-30°C - +120°C	✓	✓	3	099 868 411
IP54	PG13,5 (20,4 mm)	9 mm	30,5 mm	22 mm	6,8-13 mm	-30°C - +120°C	✓	✓	4	099 868 415
IP54	PG16 (22,5 mm)	6,3 mm	29,4 mm	24mm	6,8-14 mm	-30°C - +120°C	✓	✓	5	099 868 416
IP54	PG13,5 (20,4 mm)	9 mm	30,5 mm	22 mm	6,8-13 mm	-30°C - +120°C		✓	6	099 868 413
IP54	M 16 X 1,5	8,4 mm	28 mm	17 mm	6-10 mm	-30°C - +120°C		✓	7	099 865 216
IP54	M 20 X 1,5	9 mm	30 mm	22 mm	6,8-13 mm	-30°C - +120°C		✓	8	099 865 220

Spare parts

Nut for cable gland PG13,5	9	099 868 483
Nut for cable gland M 16 X 1,5	9	099 865 316
Nut for cable gland M 20 X 1,5	9	099 865 320

### Cable gland, ADR and Rubber seals

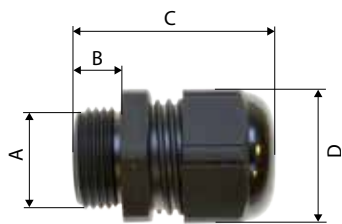

Pos 1



Pos 2

Cable gland without nut  
UV-resistant

IP Rating	A	B	C	D	Cable Ø	Working temperature	Black polyamide	Pos	Article No.
IP68-5bar	PG7 (12,5 mm)	8 mm	32 mm	15 mm	2,5-6,5 mm	-20°C - +80°C	✓	1	099 865 841
IP68-5bar	PG9 (15,2 mm)	8 mm	36 mm	19 mm	3,5-8 mm	-20°C - +80°C	✓	1	099 865 961
IP68-5bar	PG11 (18,6 mm)	8 mm	38 mm	22 mm	4-10 mm	-20°C - +80°C	✓	1	099 865 963
IP68-5bar	PG13,5 (20,4 mm)	9 mm	41 mm	24 mm	6-12 mm	-20°C - +80°C	✓	1	099 865 965
IP68-5bar	PG16 (22,5 mm)	10 mm	44 mm	27 mm	9-14 mm	-20°C - +80°C	✓	1	099 865 967
IP68-5bar	PG21 (28,3 mm)	11 mm	49 mm	33 mm	13-18 mm	-20°C - +80°C	✓	1	099 865 969

#### Spare parts

Nut for cable gland PG7	2	099 865 851
Nut for cable gland PG9	2	099 865 970
Nut for cable gland PG11	2	099 865 971
Nut for cable gland PG13,5	2	099 865 972
Nut for cable gland PG16	2	099 865 973
Nut for cable gland PG21	2	099 865 974

### Rubber seals



For cable Ø	Hole Ø	Thickness	Article No.
5-7 mm	16 mm	1-4 mm	999 876 309
7-10 mm	19 mm	1-4 mm	999 876 311
10-14 mm	23 mm	1-4 mm	999 876 316

# ELECTRONIC CONTROL UNITS & SIMAC<sup>®</sup>

---



LED Control Box

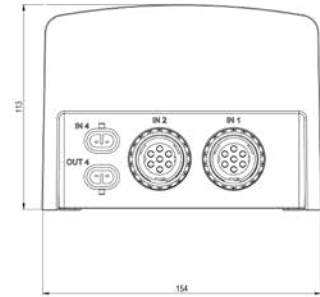
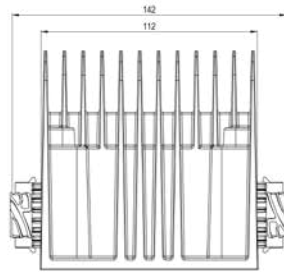

The LED control box monitors the stop-, and flasher light and complies with the ECE-48 regulations. In case of a light failure, the lamp monitoring system is activated on the towing vehicle.  
Aluminium cover

IP Rating	Connection	Out/Input	Article No.
IP67	1x15 poled Ermax Bayonet socket	2x7 poled AMP 1.5 socket for LH+RH tail lights 4x2 poled Super Seal socket for LH+RH marker lights	098 298 100
IP67	2x7 poled AMP 1.5 Socket	2x7 poled AMP 1.5 socket for LH+RH tail lights 4x2 poled Super Seal socket for LH+RH marker lights	098 298 120

## LED Control Box 12V

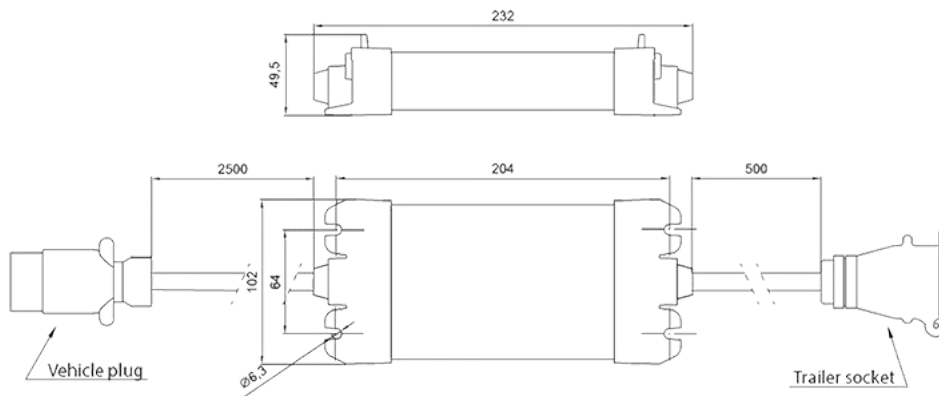
**For installations with 7 poled plug ISO1724**

To be connected between vehicle (ISO1724 plug) and trailer (ISO1724 socket)

May not be used for installations with bulb lamps

**For installations with 13-polet plug ISO11446**

To be connected between vehicle (ISO11446 plug) and trailer (ISO11446 socket)

May not be used for installations with bulb lamps

Monitoring and controlling :

- Position light, - by consumption > 30mA a 2x4W load is added
- Direction indicator light, - by consumption > 80mA a 2x17W load is added
- Stop light, - by consumption > 150mA a 1x35W load is added
- Rear fog light, - by consumption > 100mA a 1x17W load is added
- Reverse light, - by consumption > 100mA a 1x17W load is added

Dimensions (LxWxH) : 232 x 102 x 50 mm

Position of mountingholes / diameter : 204 x 64 / ø6,3 mm

Working temperatur : -40°C to +50°C

ISO Norm	IP-Rating	Connection	Cable length plug to box	Cable length socket to box	Operation voltage	Dimension	Article No.
1724	IP67	7 poled	2360 mm	370 mm	12V	232 x 102 x 50 mm	<b>098 298 150</b>
11446	IP67	13 poled	2360 mm	370 mm	12V	232 x 102 x 50 mm	<b>098 298 155</b>

## Electronic control boxes - applications

### Light failure control



Failure at an indicator must for vehicles with a permission for driving in public traffic be shown optically or acoustically. This regulation is valid for all EU countries (EU Regulation 48 Art. 6.55.8).

If there is a surveillance of the brake light at the pulling vehicle there must also be a failure indicator for the brake lights.

As a LED light has a very low consumption there might be problems with the failure control at certain trucks. The low consumption is estimated as failure of the light control and shown as a failure.

Using the ERMAX LED control box the LED tail lights are tested and a resistance for indicator and stop function is mounted.

Should the consumption of the LED fall to below 10 mA (LED light or connections are defect) the resistance is disconnected, and the failure will be shown at the dashboard in the driver's cab according to the regulation.

#### Disclaimers:

A failure control device must not have any influence on the vehicle mileage log book of the trucks, and therefore Ermax cannot grant an overall guarantee that the application will work perfectly at all trucks.



## Intelligent LED Control Units for monitoring and failure control of LED tail lights

No worries – suitable for all types of vehicles regardless of the truck

### ERMAX LED Control units Generation 2.0 – Compatible with all truck brands\*

The new ERMAX LED control units are compatible with the older monitoring technologies as well as with the new ISO13207 standard for failure control. This means, that all known vehicles and trucks regardless of production year\* can communicate with the new ERMAX LED failure control units - generation 2.0 - no matter which truck a trailer is combined with.



LED Control unit 24V, universal  
- suitable for all tail lights functions



LED Control unit 24V,  
for both directions indicator - and stop light functions



LED Control unit 24V,  
for both directions indicator- and stop light functions  
- are integrated in the tail lights TM11 and TM12



LED Control box 24V,  
for direction indicator- and stop light functions as well as  
junction box (also version with integrated SIMAC®)

\* Valid for all known brands within EU as of 12/2020

### Highlights

- ERMAX LED Control units are compatible with all brands and building-year of trucks produced in EU\*, meaning, that a trailer with ERMAX LED failure control can be combined with all towing vehicles, old as new
- Use a technology which is NOT limited to ISO13207 and therefore suitable for all vehicles\*
- Easy and flexible built-in of the small compact variants due to the long cables, meaning that they can either be mounted directly behind the tail lights or mounted further ahead at the front under the vehicle
- The combined control unit for main cable installation combines both monitoring of the light functions, SIMAC® and at the same time function as a junction box
- The new Generation 2.0 LED failure control technology is already used as an integrated part of the ERMAX tail lights TM10, TM11 and TM12
- Approvals: ADR, EMC-R10



TM10 LED tail light



TM11 LED tail light

## TECHNICAL SPECIFICATIONS

### LED Control Unit 24V Generation 2.0 - Failure control LED tail lights

#### ERMAX LED Control Units Generation 2.0 - Applications

Ermax LED control units Generation 2.0 technology is already used today in several variants in order to solve the known problems concerning light monitoring.

Generation 2.0 LED control units monitor the direction indicator light function and / or the stop light function, and ensure full failure control, when LED tail lights are used at the trailer. In case of light failure, the light monitoring system at the truck is activated according to the regulation ECE 48.

The small compact LED control unit with AMP plug connections is easily mounted in front of the tail light in the right or left side. One variant monitors the direction indicator light function (098 298 146) and can be combined with the variant which monitors the stop light function (098 298 148).

If no AMP plugs are used, a universal variant with Open-end can be used for all tail light functions (one unit per function – 098 298 144).

By a complete ERMAX lighting installation the easiest variant to use, is the combined control box, which monitors both direction indicator- and stoplight functions (098 298 160). This is also available in a variant with SIMAC® (control of flashing side marker lights) (098 298 170) and both variants function also as a junction box, where all tail light functions can be reached.

Failure control function	Inlet	Outlet	Dimension (Control unit)	Distance mounting holes	Pos.	Article No.
Universal - for all tail light functions (one unit per function)	--	400 mm cable with Open-end	120 x 52 x 30 mm	70 mm / Ø8,5 mm	1	098 298 144
Indicator light	850 mm cable with 7-poled AMP socket	600 mm cable with 7-poled AMP plug	120 x 52 x 30 mm	70 mm / Ø8,5 mm	2	098 298 146
Stop light	1.800 mm cable with 7-poled AMP socket	1.500 mm cable with 7-poled AMP plug	120 x 52 x 30 mm	70 mm / Ø8,5 mm	2	098 298 148
Indicator- and stop light (one unit per function)	Mounting at the back of the housing of TM11 og TM12 Connection with 3 spring-loaded contact pins		118 x 38 x 25 mm	-	3	098 298 149
Indicator- and stop light and also junction box*	500 mm cable with 15-poled Ermax bayonet socket	500 mm cable with 15-poled Ermax bayonet plug	285 x 270 x 170 mm	250 x 240 mm / 4 x Ø8,5mm	4	098 298 160
Indicator- and stoplight, SIMAC and junction box*	500 mm cable with 15-poled Ermax bayonet socket	500 mm cable with 15-poled Ermax bayonet plug	285 x 270 x 170 mm	250 x 240 mm / 4 x Ø8,5mm	4	098 298 170

\* The LED Control box 098 298 160 and 098 298 170 functions as junction box and give the possibility to reach outlets of all ISO12098 light connections.



# TECHNICAL SPECIFICATIONS

## LED Control Unit 24V Generation 2.0 - Failure control LED tail lights

### Examples of applications

Ex: Configuration with failure control of indicator light

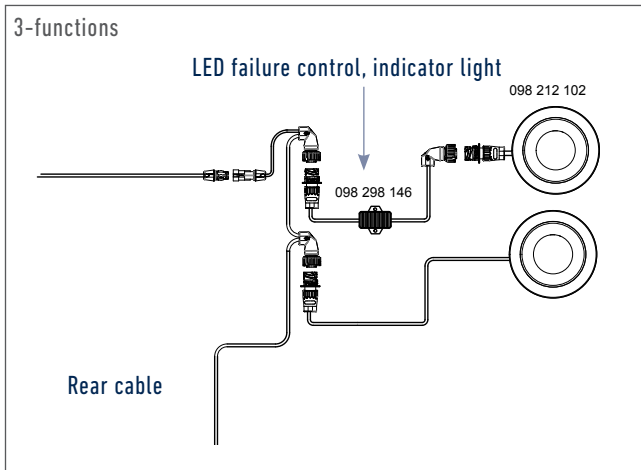

Ex: Configuration with failure control of indicator- & stop light

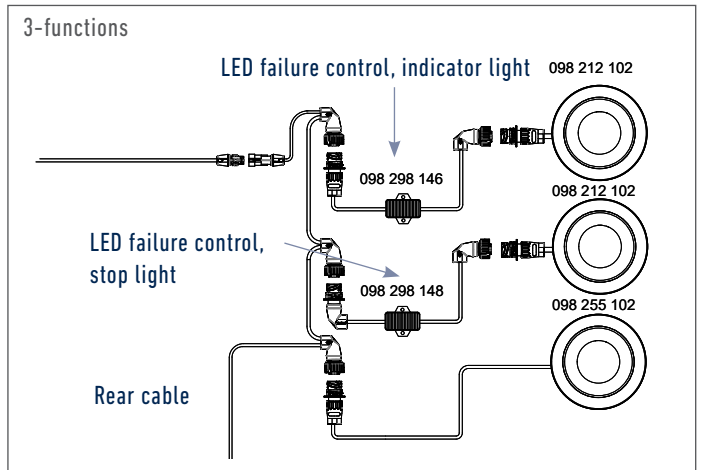

7-functions

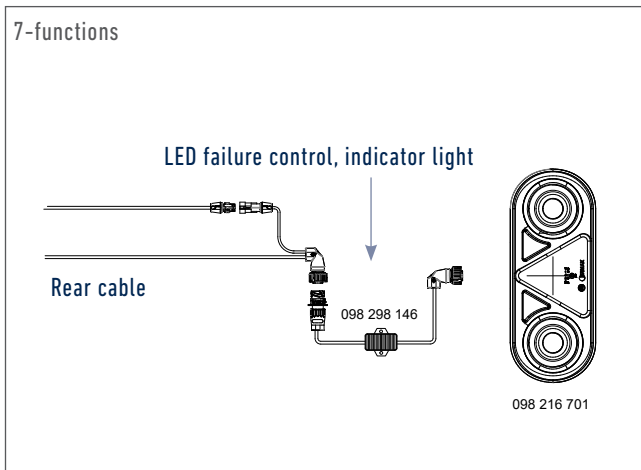

7-functions

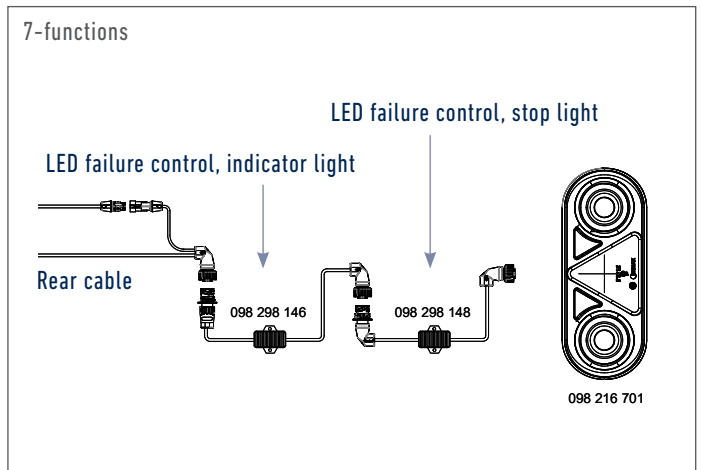

Ex: Configuration with failure control of indicator- & stop light - and junction box function

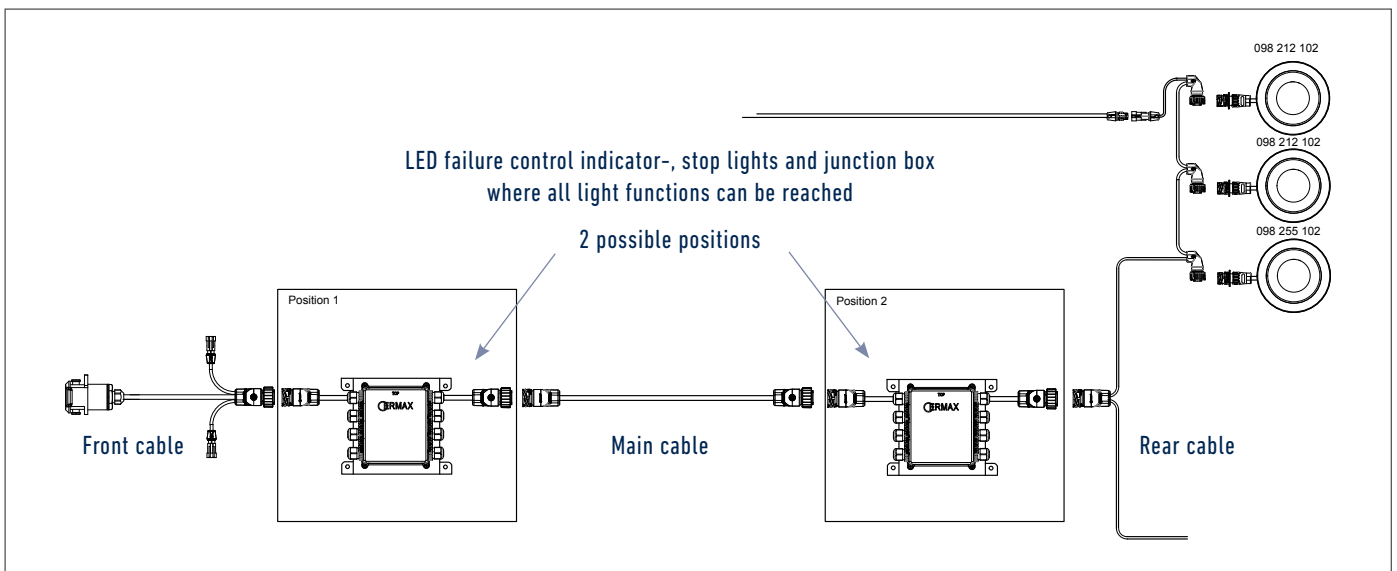

# TECHNICAL SPECIFICATIONS

## LED Control Unit 24V Generation 2.0 - Failure control LED tail lights

### Drawings / Dimensions

098 298 144

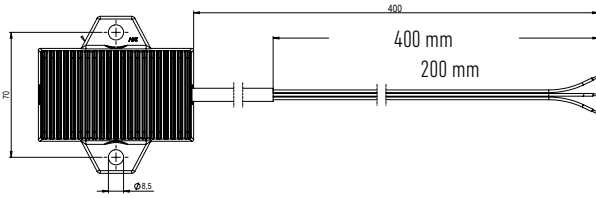

Contact assignment

Position	Colour	Function	Description
1	Brown	Ground	Minus
2	Blue	Input	Switch / Relay
3	Yellow - Green	Output	Tail light / light functions

098 298 146

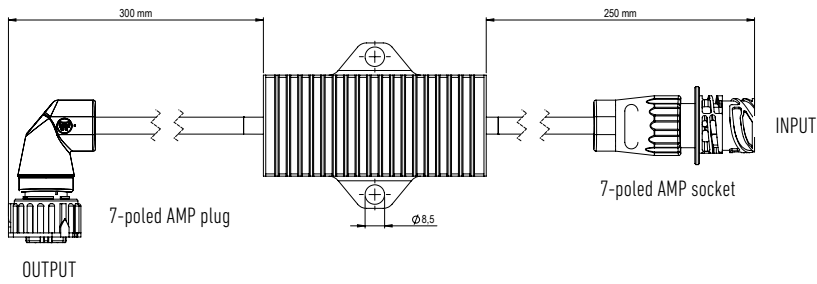

098 298 148

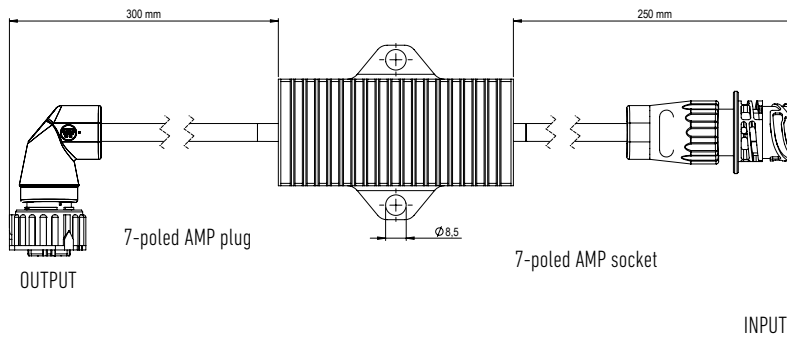

098 298 149

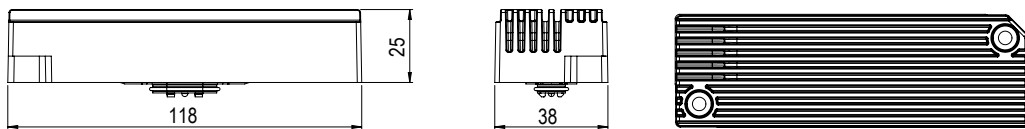

098 298 160 / 098 298 170

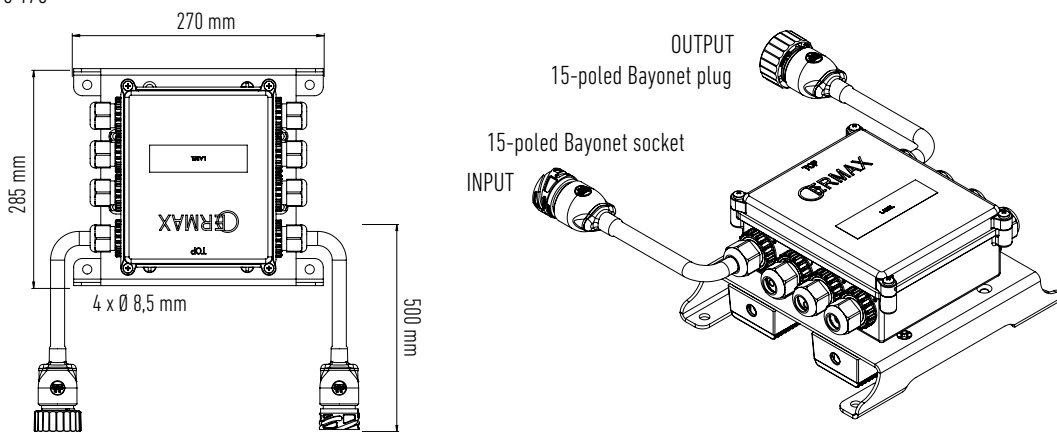

## Application overview - Vehicle brands and models

Vehicle-information				Variant of ERMAX LED control unit, which is usable*	
Vehicle brand	Type	Model	ISO13207	LED Control unit Gen. 1.0	LED Control unit Gen. 2.0
DAF	All	-		✓	✓
Iveco	All	-		✓	✓
MAN	F2000	-2000		✓	✓
	L2000	-2000		✓	✓
	M2000	-2000		✓	✓
	TG-A	2000-2007		✓	✓
	TG-L	2005-2017		✓	✓
	TG-L	2017-	✓		✓
	TG-M	2005-2016		✓	✓
	TG-M	2016-	✓		✓
	TG-S	2007-2016		✓	✓
	TG-S	2016-	✓		✓
	TG-X	2007-2016		✓	✓
Mercedes	Actros	1995-2015		✓	✓
	Actros	2015-	✓		✓
	Antos	2012-2016		✓	✓
	Antos	2016-	✓		✓
	Atego	1998-2017		✓	✓
	Atego	2017-	✓		✓
	Arocs	2013-2016		✓	✓
	Arocs	2016-	✓		✓
	Axor	2002-2017		✓	✓
	Axor	2017	✓		✓
	SK	1989-1998		✓	✓
Renault	All	-		✓	✓
Scania	92, 112, 142			✓	✓
	93, 113, 123, 143			✓	✓
	94, 114, 124, 144, 164	1995-2005		✓	✓
	P, R, T Series	2004-2017		LED Control unit not necessary	
	P, R, T Series	2018-	✓		✓
	G-Series	2007-		LED Control unit not necessary	
Volvo	FH I	1993-2012		✓	✓
	FH II	2012-		LED Control unit not necessary	
	FL I	1986-1999		✓	✓
	FL II	1999-2013		✓	✓
	FL II	2013-		LED Control unit not necessary	
	FM I	1998-2001		✓	✓
	FM II	2001-2010		✓	✓
	FM II	2010-		LED Control unit not necessary	

## The ERMAX solution is called SIMAC®

Compliant to legislation with unique flexibility

### Control of flashing side marker lights ECE 48 since November 2017

With the ECE regulation No. 48 (Changes series 06) it is prescribed that the side marker lights must flash synchronously and simultaneously with the direction indicators (in the tail light) – this is mandatory for vehicles – class 03 and 04 - being homologated after November 18 2017.

Ermax SIMAC® ensures the compliance with the legislation  
– we will advise the optimal application

**SIMAC: side marker light Control**

### SIMAC "Snap-In" Modul

Ideal for any application, even in retrofit

The flexible solution in order to keep an existing kit configuration almost unchanged

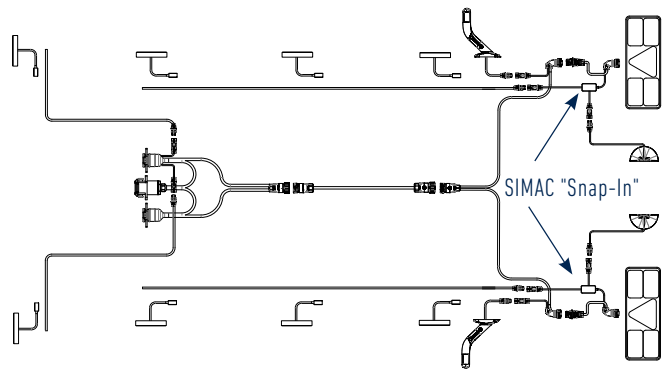

Product information in the cable section

### SIMAC integrated in the junction box

- Mounted in a secure and protected position with ideal plug connection to the system
- The best possible solution especially when 3 & 2 function lights are being used

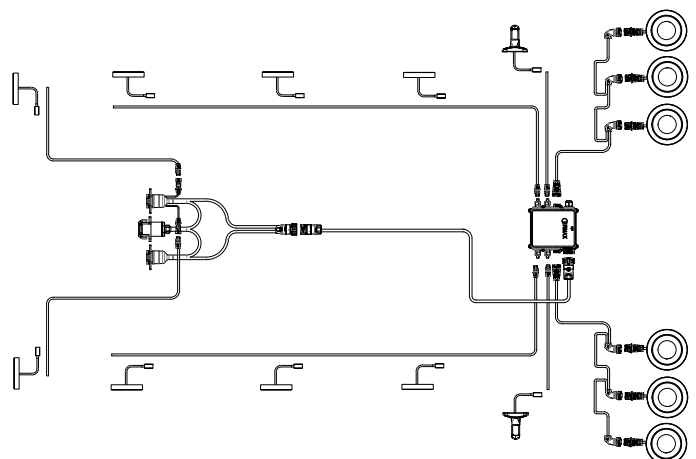

Product information in the junction box section

**SIMAC integrated in the rear cable**

- Optimised design for easy mounting
- Ideal for the lean high-volume solution

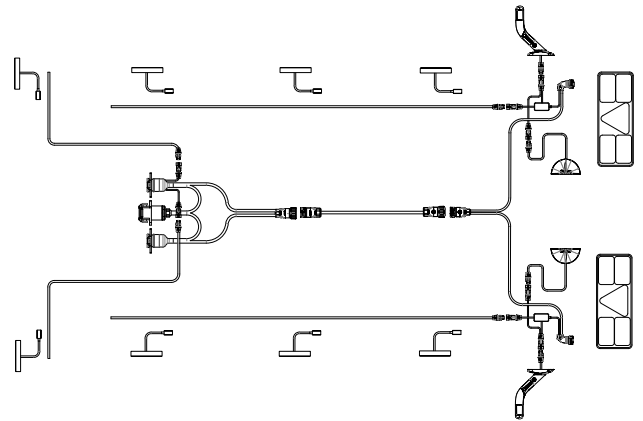
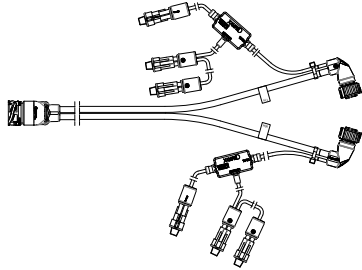

Product information in the cable section

**SIMAC as adapter in the main cable**

Allows mounting of side cables from front to back  
 Recommendable when a LED control box is used in the cable system

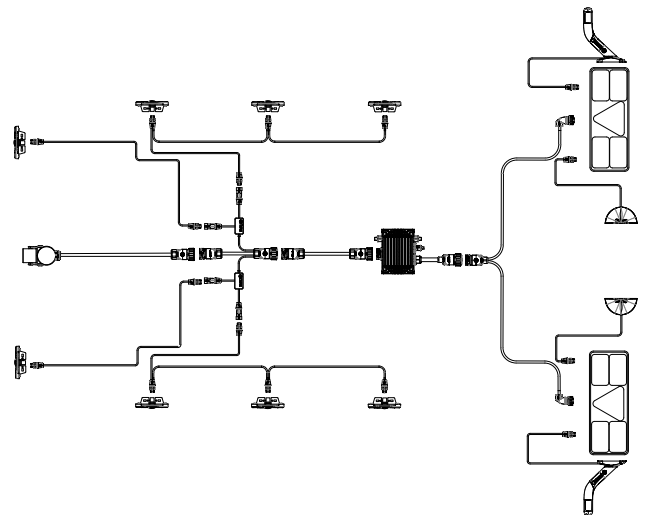
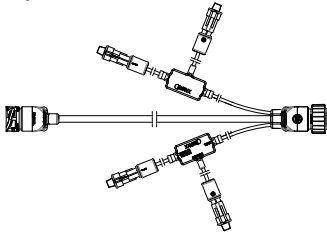

Product information in the cable section

**SIMAC in der tail light integrated**

- The easy and ideal solution without external modules
- No further parts or components needed



TM10 LED



TM11 LED

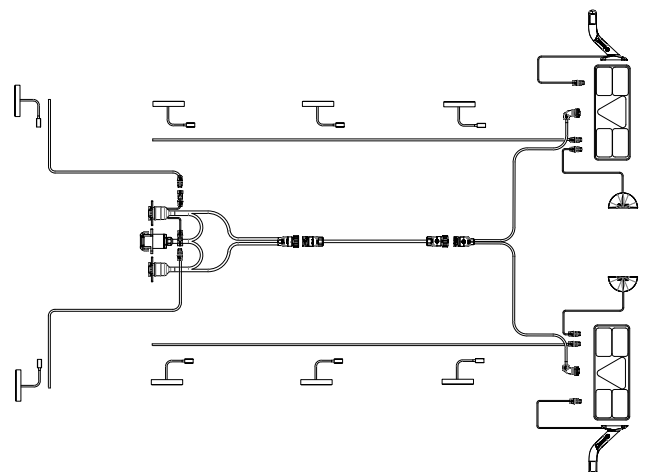

Product information in the TM10 tail light section

SIMAC - Side marker control unit

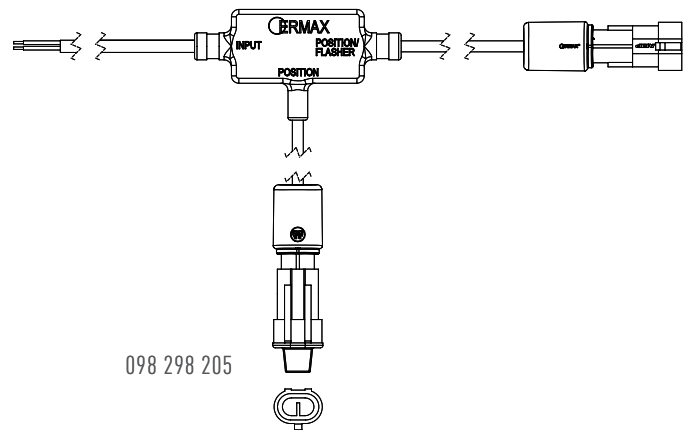
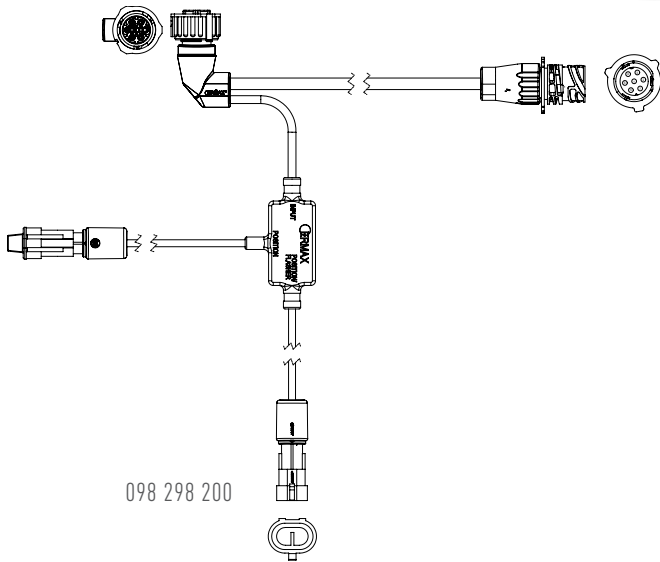

Controlling the side marker lights. By activating the direction indicator, the side marker light will flash simultaneously.

To be connected between rear cable and tail light.

With connections for outer end marker light (permanent position light) and for side marker chain

One unit for each side is required.

IP Rating	inlet	Outlet	Voltage	Article No.
IP67	1x7 poled AMP socket + 1x7 Poled AMP plug	1x Super Seal socket auf 200mm cable for permanent position light 1x Super Seal socket auf 200mm cable for side marker chain.	12/24V	098 298 200
IP67	3 core Open-End cable Ground: White Position: Green Dir. indicator: Yellow	1x Super Seal socket auf 200mm cable for permanent position light 1x Super Seal socket auf 200mm cable for side marker chain.	12/24V	098 298 205



# STANDARD CABLES FOR LIGHTING SYSTEMS

---



### Standard cables - Main cables



Pos 1

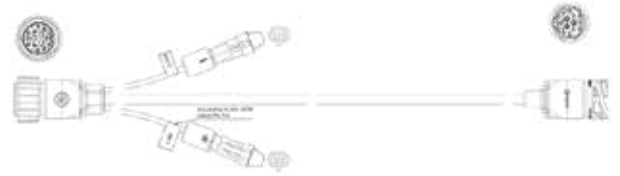

Pos 2



Pos 3

				Article No.			
Connection	Pole	Outlets	Pos	Cable length 6000 mm	Cable length 9000 mm	Cable length 13000 mm	Cable length 15000 mm
Ermac bayonet plug > socket	9	--	1	<b>394 060 100</b>	<b>394 090 100</b>	<b>394 130 100</b>	<b>394 150 100</b>
Ermac bayonet plug > socket	15	--	1	--	<b>394 090 500</b>	<b>394 130 500</b>	<b>394 150 500</b>
Ermac bayonet plug > socket	9	2x2 poled outlets with Super Seal socket (ISO 12098 pin 7 stop/pin 12 lift axle aus 3)	2		<b>394 090 101</b>	<b>394 130 101</b>	<b>394 150 101</b>
Ermac bayonet plug > socket	9	2x2 poled outlets with Super Seal socket (ISO 12098 pin 8 stop pin 12 lift axle aus 3)	2		<b>394 090 102</b>	<b>394 130 102</b>	<b>394 150 102</b>
Ermac bayonet plug > socket	9	2x2 poled outlets with Super Seal socket (ISO 12098 pin 8 reverse/ pin 9 permanent positive)	2	--	<b>394 090 105</b>	<b>394 130 105</b>	<b>394 150 105</b>
Ermac bayonet socket > Open end	15	Blade receptacles 6,3x0,8 mm	3	<b>394 060 551</b>	<b>394 090 551</b>		<b>394 150 551</b>
Open end > Ermac bayonet plug	15	Blade receptacles 6,3x0,8 mm	3	<b>394 060 571</b>	<b>394 090 571</b>	<b>394 130 571</b>	<b>394 150 571</b>

Standard cables - Rear cables

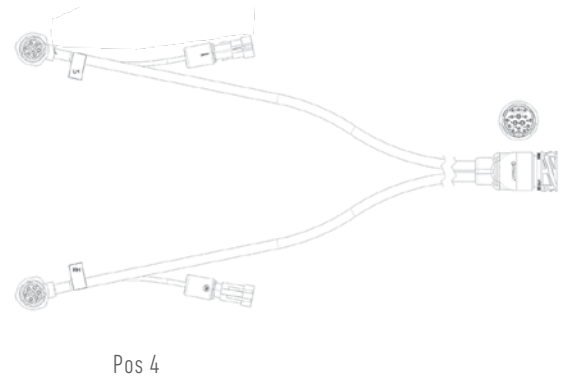
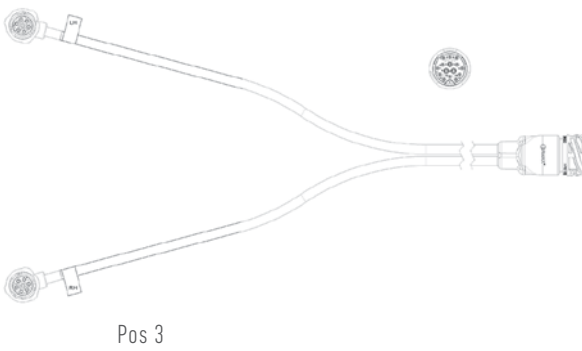
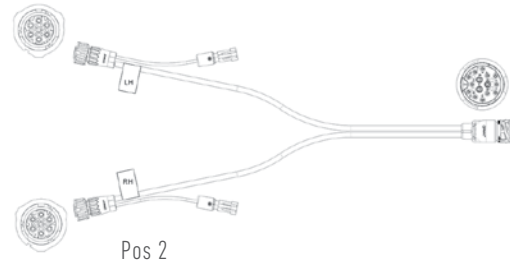
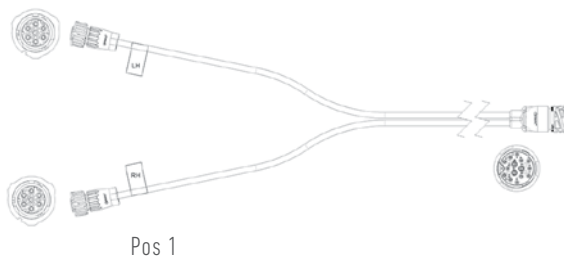

Connection	Pole	Outlets	Cable length	Pos	Article No.
Ermox bayonet socket > 2 x 7 poled AMP 1,5 plug, straight	2 x 6	--	2500 mm	1	<b>494 025 602</b>
Ermox bayonet socket > 2 x 7 poled AMP 1,5 plug, straight	2 x 6	2x2 poled outlets with Super Seal sockets for marker lights	2500 mm	2	<b>494 025 603</b>
Ermox bayonet socket > 2 x 7 poled AMP 1,5 plug, angled	2 x 6	--	2500 mm	3	<b>494 025 600</b>
Ermox bayonet socket > 2 x 7 poled AMP 1,5 plug, angled	2 x 6	2x2 poled outlets with Super Seal sockets for marker lights	2500 mm	4	<b>494 025 601</b>

Standard cables - rear cables

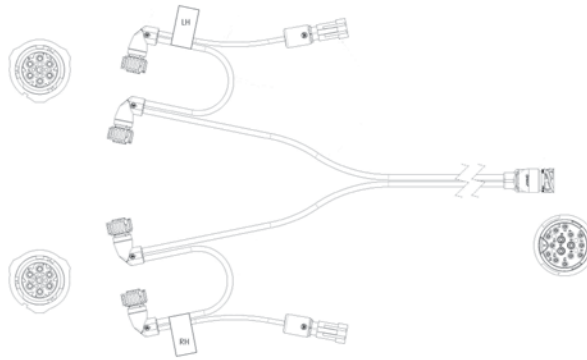

Pos 1

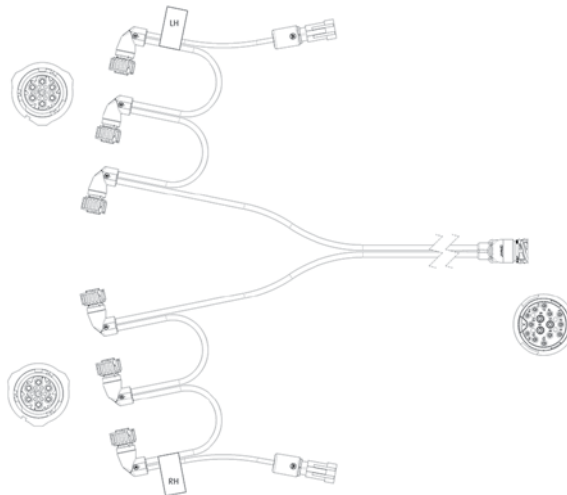

Pos 2

Connection	Poles	Outlets	Cable length	Pos	Article No.
Ermax bayonet socket > 2 x 2 7 poled AMP 1,5 plug, angled	2 x 6	2x2 poled outlets with Super Seal sockets for marker lights	2500 mm	1	<b>494 025 604</b>
Ermax bayonet socket > 2 x 3 7 poled AMP 1,5 plug, angled	2 x 6	2x2 poled outlets with Super Seal sockets for marker lights	2500 mm	2	<b>494 025 606</b>

Adapter cable



Adapter cable for Ermax tail lights  
Cable type: FLRY Y

Connection	Cable length	Conductor cross-section		Pos	Article No.
Aspöck ASS2 7 poled socket > 7 poled AMP 1.5 bayonet plug, angled	200 mm	5x1 mm <sup>2</sup> + 1x2,5 mm <sup>2</sup>	Left	1	994 002 062
Aspöck ASS2 7 poled socket > 7 poled AMP 1.5 bayonet plug, angled	200 mm	5x1 mm <sup>2</sup> + 1x2,5 mm <sup>2</sup>	Right	1	994 002 063
Hella 7 poled plug > 7 poled AMP 1.5 bayonet plug	300 mm	6x1 mm <sup>2</sup>	Left / Right	2	994 003 064
Hella 15 poled plug > Ermax 15 poled bayonet plug	200 mm	12x1 mm <sup>2</sup> + 3x2,5 mm <sup>2</sup>	---	3	994 002 151
Aspöck ASS3 17 poled plug > Ermax 15 poled bayonet plug	200 mm	12x1 mm <sup>2</sup> + 3x2,5 mm <sup>2</sup>	---	4	994 002 150



# CONNECTORS

---



## Connectors - 7 poled AMP



Pos 1



Pos 2



Pos 3



Pos 4



Pos 5



Pos 6



Pos 7



Pos 8

Application	Plug type	Poled	Pin receptacle	Pin terminal	Blue grommet	White grommet	Trans-parent end grommet	Pos	Article No.
Renault, Volvo, DAF LF	NW10, 90°	7	0,5-1,0 mm <sup>2</sup> 1,0-2,5 mm <sup>2</sup>		Ø 1,2-2,1 mm	Ø 2,2-3,0 mm	✓	1	099 111 493
Mercedes-Benz Actros	NW8,5, 90°	7	0,5-1,0 mm <sup>2</sup> 1,0-2,5 mm <sup>2</sup>		Ø 1,2-2,1 mm	Ø 2,2-3,0 mm	✓	2	099 110 617
Mercedes-Benz Axor	NW8,5 180°	7	0,5-1,0 mm <sup>2</sup> 1,0-2,5 mm <sup>2</sup>		Ø 1,2-2,1 mm	Ø 2,2-3,0 mm	✓	3	099 110 620
Scania	Cable Ø 5,0-12 mm	7	0,5-1,0 mm <sup>2</sup> 1,0-2,5 mm <sup>2</sup>		Ø 1,2-2,1 mm	Ø 2,2-3,0 mm	✓	4	099 111 481
Mercedes-Benz Sprinter, VW Crafter	Cable Ø 5,0mm 90°	7	0,5-1,0 mm <sup>2</sup> 1,0-2,5 mm <sup>2</sup>		Ø 1,2-2,1 mm	Ø 2,2-3,0 mm	✓	5	099 111 485
Universal	NW10, 180°	7		0,5-1,0 mm <sup>2</sup> 1,0-2,5 mm <sup>2</sup>	Ø 1,2-2,1 mm	Ø 2,2-3,0 mm	✓	6	099 111 534
Universal	NW8,5, 180°	7		0,5-1,0 mm <sup>2</sup> 1,0-2,5 mm <sup>2</sup>	Ø 1,2-2,1 mm	Ø 2,2-3,0 mm	✓	7	099 111 490
Universal	Cable Ø 10,0mm180°	7		0,5-1,0 mm <sup>2</sup> 1,0-2,5 mm <sup>2</sup>	Ø 1,2-2,1 mm	Ø 2,2-3,0 mm	✓	8	099 111 541

## Spare parts

Nut	099 111 292
Pins 0,5-1mm <sup>2</sup> and seals for 7 poled AMP plug – Female - (Bag with 20 x pins; 0,5-1mm <sup>2</sup> , 20 x seals)	099 111 400
Pins 0,5-1mm <sup>2</sup> and seals for 7 poled AMP plug – Male - (Bag with 20 x pins; 0,5-1mm <sup>2</sup> , 20 x seals)	099 111 402
Pins 1-2,5mm <sup>2</sup> and seals for 7 poled AMP plug – Female - (Bag with 20 x pins; 1-2,5mm <sup>2</sup> , 20 x seals)	099 111 600
Pins 1-2,5mm <sup>2</sup> and seals for 7 poled AMP plug – Male - (Bag with 20 x pins; 1-2,5mm <sup>2</sup> , 20 x seals)	099 111 602



## Connectors



Application	Plug type	Poled	Pin receptacle	Pin receptacle	Grommet	Grommet colour	End grommet colour	Pos	Article No.
Universal	Cable Ø 5,0 mm, 90°	4		0,5-1,0 mm <sup>2</sup>	Ø 1,2-2,1 mm	Grey	Transparent	2	<b>099 110 469</b>
MAN		4	0,5-1,0 mm <sup>2</sup>		Ø 1,2-2,1 mm	Red/brown	Green	3	<b>099 110 622</b>
Universal		4		1,0-2,5 mm <sup>2</sup>		Yellow		4	<b>099 110 468*</b>
MAN TG-A	NW8,5, 180°	7	0,5-1,0 mm <sup>2</sup> 1,0-2,5 mm <sup>2</sup>		Ø 1,2-2,1 mm	Red/brown	Red/brown	5	<b>099 111 648</b>
Renault, Volvo, DAF XF 1995-2000	90°	8		0,5-1,0 mm <sup>2</sup> 1,0-2,5 mm <sup>2</sup>	Ø 1,2-2,1 mm Ø 2,2-3,0 mm	Blue White	Transparent	6	<b>099 110 618</b>
Mercedes-Benz Atego, MAN F2000, DAF	90°	8		0,75-1,5 mm <sup>2</sup> 1,5-2,5 mm <sup>2</sup>	Ø 1,9-3,0 mm	Red/brown	Red/brown	7	<b>099 110 629</b>
Iveco Cargo, Stralis, Eurotech		10	0,5-1,0 mm <sup>2</sup>		Ø 1,8-2,4 mm	Yellow/red	Transparent	8	<b>099 110 647</b>

\* one-hole rubbergrommet

## Connectors - 2 poled



Application	Plug type	Poled	Plug contacts	Pin receptacle	Blade terminal	Blue grommet	Pos	Article No.
MAN	NW4,5-8,5	2	0,5-1,0 mm <sup>2</sup>			Ø 1,2-2,1 mm	1	099 111 410
MAN	NW4,5-8,5	2			0,5-1,0 mm <sup>2</sup>	Ø 1,2-2,1 mm	2	099 111 439
MAN F2000	--	2			0,5-1,0 mm <sup>2</sup>	Ø 1,2-2,1 mm	3	099 111 444
Mercedes-Benz Actros, Atego	--	2		0,5-1,0 mm <sup>2</sup>		Ø 1,2-2,1 mm	4	099 111 116
Scania	NW7,5	2		0,5-1,0 mm <sup>2</sup>		Ø 1,2-2,1 mm	5	099 110 635
Volvo	NW8,5	2		0,5-1,0 mm <sup>2</sup>		Ø 1,2-2,1 mm	6	099 110 636

## Spare parts

Coupling							7	099 111 669
----------	--	--	--	--	--	--	---	-------------

## Connectors - 2 poled Super Seal



Pos 1



Pos 2



Pos 3



Pos 4

Plug type	Poled	Pin receptacle	Pin terminal	Yellow grommet	Pos	Article No.
Super Seal	2	0,5-1,0 mm <sup>2</sup>		∅ 1,8-2,4 mm	1	<b>099 110 019</b>
Super Seal NW4.5	2	0,5-1,0 mm <sup>2</sup>		∅ 1,8-2,4 mm	2	<b>099 110 129</b>
Super Seal NW7.5-10	2	0,5-1,0 mm <sup>2</sup>		∅ 1,8-2,4 mm	3	<b>099 110 130</b>
Super Seal	2		0,5-1,0 mm <sup>2</sup>	∅ 1,8-2,4 mm	4	<b>099 110 018</b>

## Connectors - 2 poled Super Seal



Pos 1



Pos 2

Plug type	Poled	Pin receptacle	Pin terminal	Yellow grommet	Pos	Article No.
Super Seal NW4,5	2		0,5-1,0 mm <sup>2</sup>	∅ 1,8-2,4 mm	1	<b>099 110 365</b>
Super Seal NW7.5-10	2		0,5-1,0 mm <sup>2</sup>	∅ 1,8-2,4 mm	2	<b>099 110 366</b>

Connectors

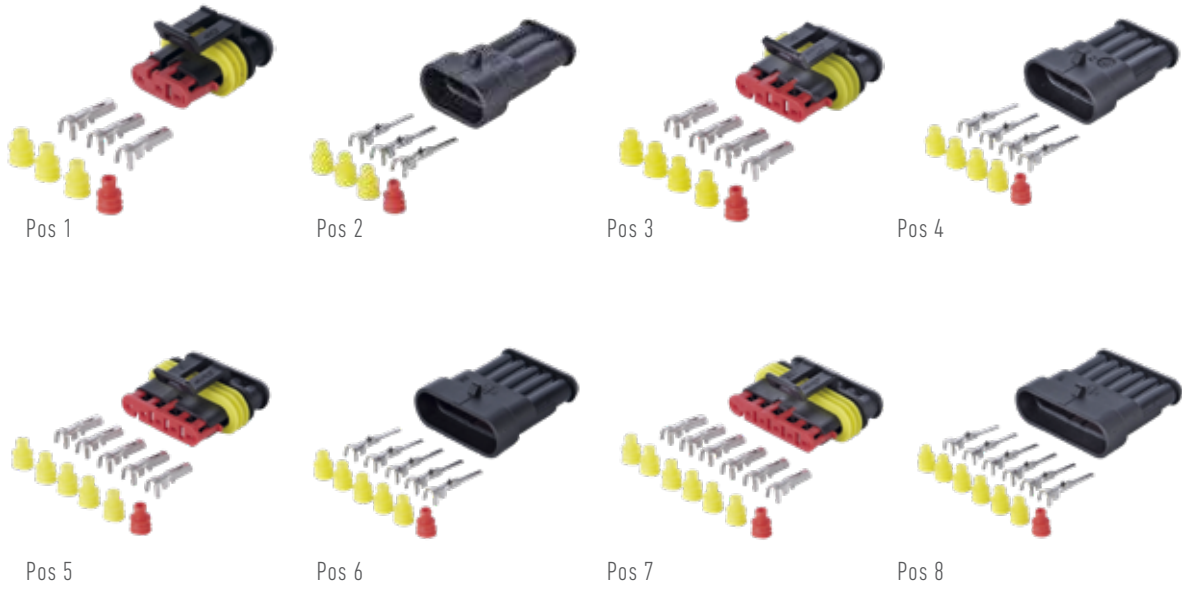

Plug type	Poled	Pin receptacle	Pin terminal	Yellow grommet	Red end grommet	Pos	Article No.
Super Seal	3	0,5-1,0 mm <sup>2</sup>		Ø 1,8-2,4 mm	✓	1	099 111 102
Super Seal	3		0,5-1,0 mm <sup>2</sup>	Ø 1,8-2,4 mm	✓	2	099 111 103
Super Seal	4	0,5-1,0 mm <sup>2</sup>		Ø 1,8-2,4 mm	✓	3	099 111 032
Super Seal	4		0,5-1,0 mm <sup>2</sup>	Ø 1,8-2,4 mm	✓	4	099 111 026
Super Seal	5	0,5-1,0 mm <sup>2</sup>		Ø 1,8-2,4 mm	✓	5	099 111 104
Super Seal	5		0,5-1,0 mm <sup>2</sup>	Ø 1,8-2,4 mm	✓	6	099 111 105
Super Seal	6	0,5-1,0 mm <sup>2</sup>		Ø 1,8-2,4 mm	✓	7	099 111 106
Super Seal	6		0,5-1,0 mm <sup>2</sup>	Ø 1,8-2,4 mm	✓	8	099 111 107

Spare parts

T-coupling, 2 pol suitable for 099 111 102 / 103	099 111 415
Terminal/grommets	099 111 100
Terminal/grommets	099 111 101

## Connectors



Pos 1



Pos 2



Pos 3



Pos 4



Pos 5



Pos 6

Application	Plug type	Poled	Pin receptacle	Red grommet	Blue grommet	Transparent end grommet	Pos	Article No.
Volvo		2	0,5-1,0 mm <sup>2</sup>	∅ 1,8-2,4 mm			1	099 110 658
MAN		2	0,5-1,0 mm <sup>2</sup>	∅ 1,8-2,4 mm			2	099 111 689
Universal	JPT 2PK1	3	0,5-1,0 mm <sup>2</sup>		∅ 1,2-2,1 mm		3	099 110 006
Universal	JPT 2PK1 NW4,5 180°	2	0,5-1,0 mm <sup>2</sup>		∅ 1,2-2,1 mm		4	099 110 386
Renault	JPT 2PK1 NW10	2	0,5-1,0 mm <sup>2</sup>		∅ 1,2-2,1 mm		5	099 110 741
Universal	JPT 3PK2	3	0,5-1,0 mm <sup>2</sup>		∅ 1,2-2,1 mm	✓	6	099 110 378

## Connectors - "Deutsch"



Pos 1



Pos 2



Pos 3



Pos 4



Pos 5



Pos 6

Plug type	Poled	Plug	Female terminal	Male terminal	Pin receptacle	Pin terminal	Pos	Article No.
"Deutsch"	2	Plug	✓		0,75-2,0 mm <sup>2</sup>		1	098 291 690
"Deutsch"	2	Socket		✓		0,75-2,0 mm <sup>2</sup>	2	099 111 043
"Deutsch"	4	Plug	✓		0,75-2,0 mm <sup>2</sup>		3	099 111 059
"Deutsch"	4	Socket		✓		0,75-2,0 mm <sup>2</sup>	4	099 111 054
"Deutsch"	6	Plug	✓		0,75-2,0 mm <sup>2</sup>		5	099 111 069
"Deutsch"	6	Socket		✓		0,75-2,0 mm <sup>2</sup>	6	099 111 064

## Connectors - Click-in



Pos 1

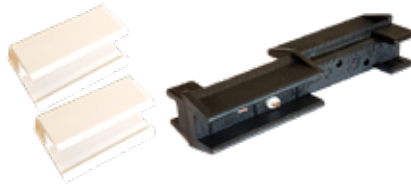

Pos 2



Pos 3

Adapter type	Must be mounted with 2 pcs.	Measurement	Connecting 2 cables	Pos	Article No.
Dual click-in	098 291 950 (not included)	68 x 22,1 x 15,4 mm	1,5 mm <sup>2</sup> flat cable	1	<b>099 110 030</b>
Dual click-in	098 291 950 (2 pcs. included)	68 x 22,1 x 15,4 mm	1,5 mm <sup>2</sup> flat cable	2	<b>099 110 032</b>
End plug for flat cable 1,5 mm <sup>2</sup> for click-in. Dimension: Ø15 x 35 mm				3	<b>099 110 031</b>

Connectors



Pos 1



Pos 2

Plug type	Poled	Cable length	Suitable for	Pos	Article No.
5 poled plug, left	5			1	098 295 076
5 poled plug, right	5			2	098 295 078



# INSTALLATION MATERIAL

---

WIRES - CABLES - CABLE TIES



## Cable, single wire



FLY type. Cable on spool

Colour		Material	Operation voltage	mm <sup>2</sup>	Length	Article No.
Black		PVC outer insulation	Max. 50V	1 x 0,75 mm <sup>2</sup>	100 m	099 990 001
Red		PVC outer insulation	Max. 50V	1 x 0,75 mm <sup>2</sup>	100 m	099 990 002
Brown		PVC outer insulation	Max. 50V	1 x 0,75 mm <sup>2</sup>	100 m	099 990 003
Blue		PVC outer insulation	Max. 50V	1 x 0,75 mm <sup>2</sup>	100 m	099 990 004
Green		PVC outer insulation	Max. 50V	1 x 0,75 mm <sup>2</sup>	100 m	099 990 005
Yellow		PVC outer insulation	Max. 50V	1 x 0,75 mm <sup>2</sup>	100 m	099 990 006
White		PVC outer insulation	Max. 50V	1 x 0,75 mm <sup>2</sup>	100 m	099 990 007
Grey		PVC outer insulation	Max. 50V	1 x 0,75 mm <sup>2</sup>	100 m	099 990 008
Amber		PVC outer insulation	Max. 50V	1 x 0,75 mm <sup>2</sup>	100 m	099 990 009
Violet		PVC outer insulation	Max. 50V	1 x 0,75 mm <sup>2</sup>	100 m	099 990 010
Pink		PVC outer insulation	Max. 50V	1 x 0,75 mm <sup>2</sup>	100 m	099 990 019
Black		PVC outer insulation	Max. 50V	1 x 0,50 mm <sup>2</sup>	100 m	099 990 021
Yellow		PVC outer insulation	Max. 50V	1 x 0,50 mm <sup>2</sup>	100 m	099 990 026
White		PVC outer insulation	Max. 50V	1 x 0,50 mm <sup>2</sup>	100 m	099 990 027
Pink		PVC outer insulation	Max. 50V	1 x 0,50 mm <sup>2</sup>	100 m	099 990 031
Black		PVC outer insulation	Max. 50V	1 x 1,0 mm <sup>2</sup>	100 m	099 990 051
Red		PVC outer insulation	Max. 50V	1 x 1,0 mm <sup>2</sup>	100 m	099 990 052
Black		PVC outer insulation	Max. 50V	1 x 1,5 mm <sup>2</sup>	100 m	099 991 101
Red		PVC outer insulation	Max. 50V	1 x 1,5 mm <sup>2</sup>	100 m	099 991 102
Brown		PVC outer insulation	Max. 50V	1 x 1,5 mm <sup>2</sup>	100 m	099 991 103
Blue		PVC outer insulation	Max. 50V	1 x 1,5 mm <sup>2</sup>	100 m	099 991 104
Green		PVC outer insulation	Max. 50V	1 x 1,5 mm <sup>2</sup>	100 m	099 991 105
Yellow		PVC outer insulation	Max. 50V	1 x 1,5 mm <sup>2</sup>	100 m	099 991 106
White		PVC outer insulation	Max. 50V	1 x 1,5 mm <sup>2</sup>	100 m	099 991 107
Grey		PVC outer insulation	Max. 50V	1 x 1,5 mm <sup>2</sup>	100 m	099 991 108
Amber		PVC outer insulation	Max. 50V	1 x 1,5 mm <sup>2</sup>	100 m	099 991 109
Black		PVC outer insulation	Max. 50V	1 x 2,5 mm <sup>2</sup>	50 m	099 992 201
Red		PVC outer insulation	Max. 50V	1 x 2,5 mm <sup>2</sup>	50 m	099 992 202
Brown		PVC outer insulation	Max. 50V	1 x 2,5 mm <sup>2</sup>	50 m	099 992 203
Yellow		PVC outer insulation	Max. 50V	1 x 2,5 mm <sup>2</sup>	50 m	099 992 206
White		PVC outer insulation	Max. 50V	1 x 2,5 mm <sup>2</sup>	50 m	099 992 207
Grey		PVC outer insulation	Max. 50V	1 x 2,5 mm <sup>2</sup>	50 m	099 992 209
Black		PVC outer insulation	Max. 50V	1 x 4,0 mm <sup>2</sup>	50 m	099 994 401
Red		PVC outer insulation	Max. 50V	1 x 4,0 mm <sup>2</sup>	50 m	099 994 402
Black		PVC outer insulation	Max. 50V	1 x 6,0 mm <sup>2</sup>	50 m	099 996 601
Red		PVC outer insulation	Max. 50V	1 x 6,0 mm <sup>2</sup>	50 m	099 996 602

## Motor vehicle cables, round



Max. 60 Volt. PVC insulation  
Operating temperature: -40°C - +85°C

ISO Norm	color	Wire colours	Material	Type	mm <sup>2</sup>	Length	Unit	Pos	Article No.
DIN 6722	Black	Blue, Brown	PVC	FLRYY	2 x 0,75 mm <sup>2</sup>	50 m	Spool	1	<b>099 897 302</b>
DIN 6722	Black	Blue, Brown	PVC	FLRYY	2 x 1,0 mm <sup>2</sup>	50 m	Spool	1	<b>099 897 304</b>
DIN 6722	Black	Blue, Brown	PVC	FLRYY	2 x 1,5 mm <sup>2</sup>	50 m	Spool	1	<b>099 897 306</b>
DIN 6722	Black	Blue, Brown, Black	PVC	FLRYY	3 x 1,0 mm <sup>2</sup>	50 m	Spool	1	<b>099 897 334</b>
DIN 6722	Black	Blue, Brown, Black	PVC	FLRYY	3 x 1,5 mm <sup>2</sup>	50 m	Spool	1	<b>099 897 336</b>
DIN 6722	Black	Black, Brown, Blue, Yellow	PVC	FLRYY	4 x 0,5 mm <sup>2</sup>	100 m	Spool	1	<b>099 897 340</b>
DIN 6722	Black	White, Brown, Red, green.	PVC	FLRYY	4 x 0,75 mm <sup>2</sup>	50 m	Spool	1	<b>099 897 342</b>
DIN 6722	Black	Blue, Brown, Black, Yellow-Green	PVC	FLRYY	4 x 1,0 mm <sup>2</sup>	50 m	Spool	1	<b>099 897 344</b>
DIN 6722	Black	Blue, Brown, Black, Yellow	PVC	FLRYY	4 x 1,5 mm <sup>2</sup>	50 m	Spool	1	<b>099 897 346</b>
DIN 6722	Black	Black, Brown, Blue, Yellow, Green	PVC	FLRYY	5 x 0,75 mm <sup>2</sup>	100 m	Spool	1	<b>099 897 353</b>
DIN 6722	Black	Black, Brown, Blue, Yellow, Green	PVC	FLRYY	5 x 1,0 mm <sup>2</sup>	50 m	Spool	1	<b>099 897 354</b>
DIN 6722	Black	Black, Brown, Blue, Yellow, Green	PVC	FLRYY	5 x 1,5 mm <sup>2</sup>	50 m	Spool	1	<b>099 897 356</b>
DIN 6722	Black	White, Red, brown, Green, Yellow, Black.	PVC	FLRYY	6 x 1,0 mm <sup>2</sup>	50 m	Spool	1	<b>099 897 360</b>
DIN 6722	Black	Brown, Yellow, White, Red, Blue, Green, Black	PVC	FLRYY	6 x 1,0 + 1 x 0,75 mm <sup>2</sup>	50 m	Roll	2	<b>099 897 380</b>
DIN 6722	Black	Black, Brown, Blue, White, Red, Green, Yellow	PVC	FLRYY	7 x 0,75 mm <sup>2</sup>	100 m	Roll	2	<b>099 897 373</b>
DIN 6722	Black	Black, Brown, Blue, White, Red, Green, Yellow	PVC	FLRYY	7 x 1,0 mm <sup>2</sup>	100 m	Roll	2	<b>099 897 375</b>
DIN 6722	Black	Brown, white	PVC	Ylyp-s, Side cable, flat for click-in	2 x 0,75 mm <sup>2</sup>	50 m	Spool	1	<b>099 897 615</b>

## ADR cable



Pos 1



Pos 2

Double insulated. Max. 50 Volt

Oil resistant

Operating temperature: -40°C - +80°C

ISO norm	Colour	Wire colours	Material	mm <sup>2</sup>	Length	Unit	Pos	Article No.
DIN 72570 + ISO 6622	Black	Red, Black	PVC	2 x 1,0 mm <sup>2</sup>	50 m	Roll	2	099 897 226
DIN 72570 + ISO 6622	Black	Blue, Brown, Black, Yellow-Green	PVC	4 x 1,0 mm <sup>2</sup>	50 m	Spool	1	099 897 045
DIN 72570 + ISO 6622	Black	Black, Brown, Blue, Yellow, Green	PVC	5 x 1,0 mm <sup>2</sup>	50 m	Spool	1	099 897 055
DIN 72570 + ISO 6622	Black	Brown, Yellow, White, Red, Blue, Green, Black	PVC	6 x 1,0 + 1 x 2,5 mm <sup>2</sup>	50 m	Spool	1	099 897 081
DIN 72570 + ISO 6622	Black	Black, Brown, Blue, White, Red, Yellow, Green	PVC	7 x 1,0 mm <sup>2</sup>	100 m	Spool	1	099 897 076
DIN 72570 + ISO 6622	Black	Amber, White, White-Red, Black, Yellow, Red, Green, Brown, Blue, Pink, Grey, White-Black, White-Blue, White-Green, White-Brown	PVC	12 x 1mm <sup>2</sup> + 3 x 2,5mm <sup>2</sup>	50 m	Spool	1	099 897 299
DIN 72570 + ISO 6622	Black	White, Brown	PVC	2 x 1,5 mm <sup>2</sup>	100 m	Spool	1	099 897 611
DIN 72570 + ISO 6622	Black	Blue, Brown, Black	PVC	3 x 1,5 mm <sup>2</sup>	50 m	Spool	1	099 897 032
DIN 72570 + ISO 6622	Black	Blue, Brown, Black, Yellow	PVC	4 x 1,5 mm <sup>2</sup>	50 m	Spool	1	099 897 049
DIN 72570 + ISO 6622	Black	Black, Brown, Blue, White, Red, Green, Yellow	PVC	7 x 1,5 mm <sup>2</sup>	50 m	Spool	1	099 897 079
DIN 72570 + ISO 6622	Black	Brown, Clear, 2 x Blue, Red, Amber, Yellow, Grey, Violet, Beige, Black, White, Green	PVC	10 x 1,5 + 3 x 2,5 mm <sup>2</sup>	25 m	Spool	1	099 897 134
DIN 72570 + ISO 6622	Black	Black, Brown, Red, Pink, Grey, Yellow, Green, Blue, White, Amber, Red-White, Black-White, Brown-White, Green- White, Blue-White	PVC	12 x 1,5 + 3 x 2,5 mm <sup>2</sup>	50 m	Roll	2	099 897 296

## Installation cable



PN-E 50525-2-11

Fine wired copper conductor





Operating temperature: -40°C - +70°C

Colour		Wire colours	Material	Type	Operation voltage	mm <sup>2</sup>	Length	Unit	Article No.
Black		Blue, Brown	PVC	H05VV-F	300/500V	2 x 0,75 mm <sup>2</sup>	100 m	Spool	<b>099 897 303</b>
Black		Blue, Brown, Yellow-Green	PVC	H05VV-F	300/500V	3 x 0,75 mm <sup>2</sup>	100 m	Spool	<b>099 897 333</b>
Black		Blue, Brown	PVC	H05VV-F	300/500V	2 x 1,0 mm <sup>2</sup>	100 m	Spool	<b>099 897 305</b>
Black		Blue, Brown, Yellow-Green	PVC	H05VV-F	300/500V	3 x 1,0 mm <sup>2</sup>	50 m	Spool	<b>099 897 335</b>
Black		Blue, Brown	PVC	H05VV-F	300/500V	2 x 1,5 mm <sup>2</sup>	100 m	Spool	<b>099 897 307</b>
Black		Blue, Brown, Yellow-Green	PVC	H05VV-F	300/500V	3 x 1,5 mm <sup>2</sup>	50 m	Spool	<b>099 897 337</b>
Black		Blue, Brown, Black, Yellow, Green	PVC	H05VV-F	300/500V	4 x 1,5 mm <sup>2</sup>	50 m	Spool	<b>099 897 348</b>
White		Blue, Brown, Yellow-Green	PVC	H05VV-F	300/500V	3 x 2,5 mm <sup>2</sup>	50 m	Spool	<b>099 897 338</b>
Black		Black, Brown, White, Yellow, Red, Green, Grey, Violet	PVC	H05VV-F	300/500V	8 x 1,5 + 1 x 2,5 mm <sup>2</sup>	50 m	Carton	<b>099 897 392</b>

## Twin cable, flat



FLZY type. Fine wired copper conductor on spool

Colour		Material	Operation voltage	mm <sup>2</sup>	Length	Pos	Article No.
Red / Black		PVC	Max. 50V	2 x 0,4 mm <sup>2</sup>	100 m	1	<b>099 896 804</b>
Red / Black		PVC	Max. 50V	2 x 0,75 mm <sup>2</sup>	100 m	2	<b>099 896 807</b>
Red / Black		PVC	Max. 50V	2 x 1,5 mm <sup>2</sup>	100 m		<b>099 896 815</b>
Red / Black		PVC	Max. 50V	2 x 2,5 mm <sup>2</sup>	100 m	3	<b>099 896 825</b>

## Motor vehicle cable, oval



Pos 1



Pos 2





Pos 3



Pos 4











Fine wired copper conductor. Max. 50 Volt

Colour		Wire colours	Material	Type	mm <sup>2</sup>	Length	Unit	Pos	Article No.
Black		Blue, Brown	PVC	YLYP-S	2 x 0,75 mm <sup>2</sup>	50 m	Spool	1	099 897 322
Black		Blue, Brown	PVC	YLYP-S	2 x 1,5 mm <sup>2</sup>	50 m	Spool	2	099 897 324
Black		Blue, Brown	PVC	YLYP-S	2 x 2,5 mm <sup>2</sup>	50 m	Spool	3	099 897 326
Grey		White, Black	PVC	FLKK	2 x 4,0 mm <sup>2</sup>	50 m	Spool	4	099 897 330

## Cable ties



Operating temperature: -40°C - +85°C























Colour		Measurements	Self locked	Material PA6.6	Packing unit	Pos	Artikel-Nr.
Black		100 x 2,5 mm	✓	✓	100	1	099 871 361
Transparent		150 x 3,5 mm	✓	✓	100	8	099 871 304
Black		190 x 3,6 mm	✓	✓	100	1	099 871 307
White		200 x 4,8 mm	✓	✓	100	2	099 871 399
Green		200 x 4,8 mm	✓	✓	100	5	099 871 301
Yellow		200 x 4,8 mm	✓	✓	100	4	099 871 379
Red		200 x 4,8mm	✓	✓	100	6	099 871 389
Purple		200 x 4,8 mm	✓	✓	100	3	099 871 349
Blue		200 x 4,8 mm	✓	✓	100	7	099 871 359
Black		290 x 4,8 mm	✓	✓	100	1	099 871 309
Black		390 x 4,8 mm	✓	✓	100	1	099 871 369
Black		710 x 7,6 mm	✓	✓	50	1	099 871 075



## Hellermann Tyton - Cable ties



Operating temperature: -40°C - +85°C

Colour		Measurements	Self locked	Material PA6.6	Packing unit	Pos	Artikel-Nr.
Black		100 x 2,5 mm	✓	✓	100	1	099 871 061
Black		200 x 2,5 mm	✓	✓	100	1	999 871 250
Transparent		150 x 3,5 mm	✓	✓	100	8	099 871 004
Black		150 x 3,5 mm	✓	✓	100	1	099 871 063
Black		190 x 3,5 mm	✓	✓	100	1	099 871 007
Black		200 x 4,6 mm	✓	✓	100	1	099 871 065
Transparent		200 x 4,6 mm	✓	✓	100	8	099 871 006
White		200 x 4,6 mm	✓	✓	100	2	099 871 099
Green		200 x 4,8 mm	✓	✓	100	5	099 871 101
Yellow		200 x 4,8 mm	✓	✓	100	4	099 871 079
Red		200 x 4,8mm	✓	✓	100	6	099 871 089
Purple		200 x 4,8 mm	✓	✓	100	3	099 871 049
Blue		200 x 4,8 mm	✓	✓	100	7	099 871 059
Black		290 x 3,5 mm	✓	✓	100	1	099 871 009
Black		300 x 4,6 mm	✓	✓	100	1	099 871 067
Black		330 x 2,8 mm	✓	✓	100	1	099 871 012
Transparent		390 x 4,6 mm	✓	✓	100	8	099 871 010
Black		380 x 7,6 mm	✓	✓	100	1	099 871 077
Black		390 x 4,6 mm	✓	✓	100	1	099 871 069
Black		540x 13 mm	✓	✓	50	1	099 871 095
Black		760 x 7,6 mm	✓	✓	50	1	099 871 075
Black		1030 x 12,5 mm	✓	✓	25	1	099 871 096

## Cable ties



Pos 1



Pos 2

Colour		Measurements	Max Ø for wiring harness	Working temperature -40° - +85°	Self locked	Material PA6.6	Mounting head Ø	Steel locking lance	Pos	Article No.
Black		395 x 7,6 mm	102 mm	✓	✓	✓	6,5 mm		1	099 871 175
Black		140 x 3,5 mm	28,6 mm	✓	✓	✓		✓		099 871 114
Black		186 x 4,6 mm	44,4 mm	✓	✓	✓		✓		099 871 120

## Cable tie, with loose head



Pos 1



Pos 2



Pos 3

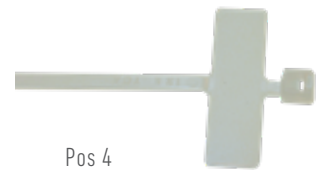

Pos 4

Colour		Measurements	Max Ø for wiring harness	Working temperature -40° - +85°	Material PA6.6	Self locked	Identification tie	Pos	Article No.
Black		370 x 7,6 mm	92 mm	✓	✓			1	099 871 170
Black		375 x 7,6 mm	102 mm	✓	✓			2	099 871 078
Black		770 x 8,8 mm	225 mm	✓	✓			3	099 871 091

## Cable clip





Pos 1



Pos 2

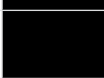
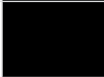

Pos 3

Colour		Measurements	Cable tie max width	For cable straps up to	Working temperature -40° - +85°	Self adhesive	Material	Fastening	Pos	Article No.
Black		19 x 19 mm	3,6 mm			✓	PA6.6	Also with screw possible	1	099 871 905
White		28 x 28 mm	4,8 mm			✓	PA6.6	Also with screw possible		099 871 910
Black		28 x 28 mm	5,4 mm			✓	PA6.6	Also with screw possible		099 871 906
Black				7,6 mm width	✓		PA6.6	With screw M6	2	099 871 920
Black				8,5 mm width	✓		PA6.6	With weldingnut Ø5	3	099 871 925

## Shrink tube with glue, sortiment



Pos 1



Pos 2

Colour	Size	Shrinking temp.	Pos	Article No.
Black	3 - 1 mm / 10 m	120 - 130°C	1	<b>099 875 703</b>
Black	6 - 2 mm / 5 m	120 - 130°C	1	<b>099 875 706</b>
Black	9 - 3 mm / 5 m	120 - 130°C	1	<b>099 875 709</b>
Black	12 - 4 mm / 5 m	120 - 130°C	1	<b>099 875 712</b>
Black	18 - 4 mm / 5 m	120 - 130°C	1	<b>099 875 118</b>
Black	24 - 8 mm / 3 m	120 - 130°C	1	<b>099 875 724</b>
Black	3 - 1 mm / 1,2 m	120 - 130°C	2	<b>099 875 103</b>
Black	6 - 2 mm / 1,2 m	120 - 130°C	2	<b>099 875 106</b>
Black	9 - 3 mm / 1,2 m	120 - 130°C	2	<b>099 875 109</b>
Black	12 - 4 mm / 1,2 m	120 - 130°C	2	<b>099 875 112</b>
Black	19 - 6 mm / 1,2 m	120 - 130°C	2	<b>099 875 119</b>
Black	24 - 8 mm / 1,2 m	120 - 130°C	2	<b>099 875 124</b>
Black	32 - 8 mm / 1,2 m	120 - 130°C	2	<b>099 875 132</b>
Black	39 - 13 mm / 1,2 m	120 - 130°C	2	<b>099 875 139</b>
Black	52 - 13 mm / 1,2 m	120 - 130°C	2	<b>099 875 145</b>
Black	12 - 5 mm / 10,0 m	120 - 130°C	2	<b>099 875 162</b>

## Insulating tubing



Material	Working temp.	Ø	Roll	Article No.
Black pvc	-40 - +90°C	4,0 mm	100 m	<b>099 875 004</b>
Black pvc	-40 - +90°C	5,0 mm	100 m	<b>099 875 005</b>
Black pvc	-40 - +90°C	6,0 mm	100 m	<b>099 875 006</b>
Black pvc	-40 - +90°C	7,0 mm	100 m	<b>099 875 007</b>
Black pvc	-40 - +90°C	8,0 mm	50 m	<b>099 875 008</b>
Black pvc	-40 - +90°C	10 mm	50 m	<b>099 875 010</b>
Black pvc	-40 - +90°C	12,0 mm	50 m	<b>099 875 012</b>
Black pvc	-40 - +90°C	14,0 mm	50 m	<b>099 875 014</b>
Black pvc	-40 - +90°C	16,0 mm	50 m	<b>099 875 016</b>
Black pvc	-40 - +90°C	20,0 mm	50 m	<b>099 875 020</b>

## Spiralflex



Fire retardant

Material	Colour	Working temp.	Outer Ø	Inner Ø	Max Ø	Length	Article No.
Polyetylen (PE)	Black	-60 - +80°C	12 mm	9 mm	100 mm	30 m	<b>099 875 409</b>
Polyetylen (PE)	Black	-60 - +80°C	16 mm	13 mm	150 mm	30 m	<b>099 875 420</b>

## Corrugated pipe, slit



Material	Colour	NW	Length	Article No.
Polyflex	Black	4,5	100 m	<b>099 877 304</b>
Polyflex	Black	8,5	50 m	<b>099 877 308</b>
Polyflex	Black	10,0	50 m	<b>099 877 310</b>
Polyflex	Black	14,0	50 m	<b>099 877 314</b>
Polyflex	Black	17,0	50 m	<b>099 877 317</b>

## Corrugated pipe



Material	Colour	NW	Ø	Length	Article No.
Polyflex	Black	7,5	10	50 m	<b>099 877 207</b>
Polyflex	Black	8,5	11,7	50 m	<b>099 877 208</b>
Polyflex	Black	10,0	13	50 m	<b>099 877 210</b>
Polyflex	Black	13,0	15,8	50 m	<b>099 877 213</b>
Polyflex	Black	16,0	18,9	50 m	<b>099 877 216</b>
Polyflex	Black	17,0	21,2	50 m	<b>099 877 217</b>
Polyflex	Black	22,0	25,4	50 m	<b>099 877 222</b>
Polyflex	Black	23,0	28,3	50 m	<b>099 877 223</b>
Polyflex	Black	26,0	31,2	25 m	<b>099 877 226</b>
Polyflex	Black	29,0	34,5	25 m	<b>099 877 229</b>
Polyflex	Black	37,0	42,4	25 m	<b>099 877 237</b>
Polyflex	Black	50,0	54	25 m	<b>099 877 250</b>





# INSTALLATION MATERIAL

---

## STARTER CABLES



## Battery jump lead, PVC



Professional booster cables.

Fine wired copper conductor core with thermoplastic sheath, PVC.

Extremely flexible. Loading clamps in casted brass

Working length	mm <sup>2</sup>	Max. A	Article No.
3,5 m	35 mm <sup>2</sup>	500A	099 887 335
5,0 m	35 mm <sup>2</sup>	500A	099 887 350
3,5 m	50 mm <sup>2</sup>	750A	099 887 535

### Spare parts

Battery loading tong, red	099 885 841
Battery loading tong, black	099 885 851

## Twin starter cable



Round on roll. Fine wired copper conductor.

Operating temperature: -40°C - +100°C

Colour	Material	Operation voltage	mm <sup>2</sup>	Length	Article No.
Red/Black	PVC insulation	Max. 50V	2 x 6 mm <sup>2</sup>	50 m	099 898 206
Red/Black	PVC insulation	Max. 50V	2 x 10 mm <sup>2</sup>	50 m	099 898 210
Red/Black	PVC insulation	Max. 50V	2 x 16 mm <sup>2</sup>	50 m	099 898 216
Red/Black	PVC insulation	Max. 50V	2 x 25 mm <sup>2</sup>	50 m	099 898 225
Red/Black	PVC insulation	Max. 50V	2 x 35 mm <sup>2</sup>	50 m	099 898 235
Red/Black	PVC insulation	Max. 50V	2 x 50 mm <sup>2</sup>	25 m	099 898 250

## Starter cable



Pos 1



Pos 2

Round on roll. Fine wired copper conductor.

Operating temperature: -40°C - +100°C

Colour		Material	Type	Operation voltage	mm <sup>2</sup>	Length	Article No.
Black		Soft PVC insulation	FLY	Max. 50V	1 x 10 mm <sup>2</sup>	50 m	<b>099 898 312</b>
Red		Soft PVC insulation	FLY	Max. 50V	1 x 10 mm <sup>2</sup>	50 m	<b>099 898 313</b>
Black		Soft PVC insulation	FLY	Max. 50V	1 x 16 mm <sup>2</sup>	50 m	<b>099 898 318</b>
Red		Soft PVC insulation	FLY	Max. 50V	1 x 16 mm <sup>2</sup>	50 m	<b>099 898 319</b>
Black		Soft PVC insulation	FLY	Max. 50V	1 x 25 mm <sup>2</sup>	50 m	<b>099 898 327</b>
Red		Soft PVC insulation	FLY	Max. 50V	1 x 25 mm <sup>2</sup>	50 m	<b>099 898 328</b>
Black		Soft PVC insulation	FLY	Max. 50V	1 x 35 mm <sup>2</sup>	50 m	<b>099 898 337</b>
Red		Soft PVC insulation	FLY	Max. 50V	1 x 35 mm <sup>2</sup>	50 m	<b>099 898 338</b>
Black		Soft PVC insulation	FLY	Max. 50V	1 x 50 mm <sup>2</sup>	50 m	<b>099 898 352</b>
Red		Soft PVC insulation	FLY	Max. 50V	1 x 50 mm <sup>2</sup>	50 m	<b>099 898 353</b>

### Battery loading tongs



Pos 1



Pos 2

Material	W x H	mm <sup>2</sup>	Max. A	Colour	Pos	Article No.
Casted brass – part insulated	135 x 145 mm	25-50 mm <sup>2</sup>	750A	Red	1	<b>099 885 841</b>
Casted brass – part insulated	135 x 145 mm	25-50 mm <sup>2</sup>	750A	Black	2	<b>099 885 851</b>

# INSTALLATION MATERIAL

---

BATTERI TERMINALS

ENGINE EARTH STRAPS



## Battery terminal



Material	Type	For cable	Pos	Article No.
Brass, tin-plated	Right +	25-35 mm <sup>2</sup>	1	099 880 000
Brass, tin-plated	Left +	25-35 mm <sup>2</sup>	2	099 880 002
Brass, tin-plated	Right -	25-35 mm <sup>2</sup>	3	099 880 001
Brass, tin-plated	Left -	25-35 mm <sup>2</sup>	4	099 880 003

### Spare parts

Protection cap +	5	099 880 200
Protection cap -	6	099 880 201

## Battery terminal



Material	Type	For cable	Pos	Article No.
Brass, tin-plated	Right +	35-70 mm <sup>2</sup>	1	<b>099 880 016</b>
Brass, tin-plated	Left +	35-70 mm <sup>2</sup>	1	<b>099 880 014</b>
Brass, tin-plated	Right -	35-70 mm <sup>2</sup>	2	<b>099 880 015</b>
Brass, tin-plated	Left -	35-70 mm <sup>2</sup>	2	<b>099 880 017</b>
Brass, tin-plated	+	35-70 mm <sup>2</sup>	3	<b>099 880 038</b>
Brass, tin-plated	-	35-70 mm <sup>2</sup>	3	<b>099 880 039</b>
Brass, tin-plated	+	50 mm <sup>2</sup>	5	<b>099 880 047</b>
Brass, tin-plated	-	50 mm <sup>2</sup>	5	<b>099 880 048</b>
Brass, tin-plated	+	25-70 mm <sup>2</sup>	6	<b>099 880 055</b>
Brass, tin-plated	-	25-70 mm <sup>2</sup>	6	<b>099 880 056</b>





# POWER RELAYS

---



Single contact relays with fuse, mini



Pos. 1



Pos. 2

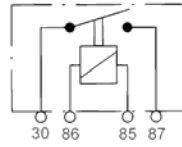

Socket

Type	Material: Plastic	Connection: Flat plug terminal 6,3 x 0,8 mm	Operation voltage	Consumption	Fuse Consumption	Brass tin-plated	Operating temperature: -40°C - +80°C	Mounting bracket incl.	Pos.	Article No.
Single contact relays with fuse	✓	✓	12V	30 A	15 A	✓	✓	✓	1	090 225 012
Single contact relays	✓	✓	24V	20A	15 A	✓	✓	✓	2	090 225 024

Spare parts

Socket for relay		090 290 008
------------------	--	-------------

Single contact relays, mini



Socket

Diagram	Socket	Material: Plastic	Connection: Flat plug terminal 6,3 x 0,8 mm	Operation voltage	Consumption	Brass tin-plated	Silver plated	Operating temperature: -40°C - +80°C	Mounting bracket incl.	2 x Consumptions "87"	Article No.
---------	--------	----------------------	---	-------------------	-------------	------------------	---------------	---	------------------------	-----------------------	-------------

		✓	✓	12V	30 A	✓		✓	✓		090 220 012
		✓	✓	24V	20 A	✓		✓	✓		090 220 024
		✓	✓	12V	40 A	✓		✓	✓		090 230 012
		✓	✓	24V	20 A	✓		✓	✓		090 230 024
		✓	✓	12V	30 A	✓		✓	✓		090 270 012
		✓	✓	24V	20 A	✓		✓	✓	✓	090 270 024
		✓	✓	12V	30 A	✓		✓	✓	✓ switch-off diode	090 270 105
		✓	✓	24V	2x10 A		✓	✓			090 275 008

Spare parts

Socket for relay	090 290 008
------------------	-------------

Single contact relays, mini



Socket

Diagram	Socket	Material: Plastic	Connection: Flat plug terminal 6,3 x 0,8 mm	Operation voltage	Consumption	Brass tin-plated	Operating temperature: -40°C - +80°C	Mounting bracket incl.	With switch-off diode	With resistance	Article No.
---------	--------	----------------------	---	-------------------	-------------	------------------	---	------------------------	-----------------------	-----------------	-------------

		✓	✓	12V	20/30 A	✓	✓	✓			090 280 012
		✓	✓	24V	10/20 A	✓	✓	✓			090 280 024
		✓	✓	12V	20/30 A	✓	✓	✓	✓	090 280 158	
		✓	✓	24V	10/20 A	✓	✓	✓	✓		090 280 204
		✓	✓	12V	30/40 A	✓	✓	✓	✓	090 280 254	
		✓	✓	12V	20/30 A	✓	✓	✓		✓	090 280 110
		✓	✓	24V	10/20 A	✓	✓	✓		✓	090 280 207

Spare parts

Socket for relay	090 290 008
------------------	-------------

Single contact relays, micro



Socket

Diagram	Socket	Material: Plastic	Connection: Terminal 1,2 = 4,8 x 0,8 Terminal 3,5 = 6,3 x 0,8	Operation voltage	Consumption	Operating temperature: -40°C - +80°C	With switch-off diode	With resistance	Article No.
---------	--------	----------------------	---	-------------------	-------------	---	-----------------------	-----------------	-------------

		✓	✓	12V	25 A	✓			090 272 103
		✓	✓	12V	25 A	✓	✓		090 272 105
		✓	✓	24V	10 A	✓		✓	090 272 200

Spare parts

Socket for relay	090 295 045
------------------	-------------

Change-over relays, micro



Socket

Diagram	Socket	Material: Plastic	Connection: Terminal 1,2,4 = 4,8 x 0,8 Terminal 3,5 = 6,3 x 0,8	Operation voltage	Consumption	Operating temperature: -40°C - +80°C	With switch-off diode	With resistance	Article No.
---------	--------	----------------------	---	-------------------	-------------	---	-----------------------	-----------------	-------------

		✓	✓	12V	15/25 A	✓			090 282 102
		✓	✓	24V	5/10 A	✓			090 282 200
		✓	✓	12V	15/25 A	✓		✓	090 282 100
		✓	✓	24V	5/10 A	✓	✓		090 282 104
		✓	✓	12V	15/25 A	✓	✓		090 282 104
		✓	✓	24V	5/10 A	✓	✓		090 282 202

Spare parts

Socket for relay	090 295 045
------------------	-------------

Power relay

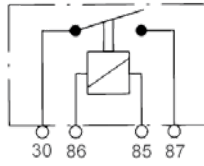

Diagram

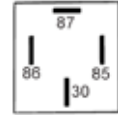

Socket

Type	Material: Plastic	Connection brass tin plated terminals (85+86)	Connection copper silver plated terminals (30+87)	Operation voltage	Consumption	Operating temperature: -40°C - +80°C	Mounting bracket incl.	Article No.
Power relay	✓	2 x 6,3 x 1,2	2 x 9,5 x 0,8	12V	70 A	✓	✓	090 285 012
Power relay	✓	2 x 6,3 x 1,2	2 x 9,5 x 0,8	24V	40 A	✓	✓	090 285 024
Power relay	✓	2 x 6,3 x 1,2	2 x 9,5 x 0,8	24V	70 A	✓	✓	090 285 026
Power relay	✓	2 x 6,3 x 1,2	2 x M6	12V	200 A	✓	✓	090 285 112
Power relay	✓	2 x 6,3 x 1,2	2 x M6	24V	100 A	✓	✓	090 285 124

Spare parts

Socket for relay	090 295 005
------------------	-------------

### Change-over power relay

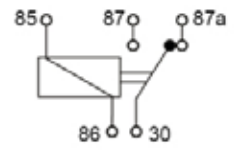
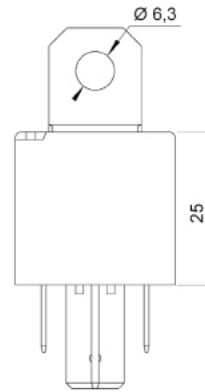
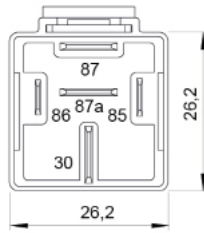

Diagram

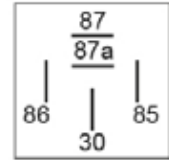

Type	Material: Plastic	Operation voltage	Consumption	Short term operation	Operating temperature: -40°C - +85°C	With resistance	Article No.
Power change over relay	✓	24V	40 A	50 A	✓	✓	090 293 243

#### Spare parts

Socket for relay	090 290 008
------------------	-------------

### Latching relay

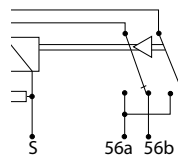

Diagram

Type	Material: Plastic	Connection: Flat plug terminal 5 x 6,3 mm	Operation voltage	Consumption	Article No.
Latching relay	✓	✓	12V	2x150W	090 899 120
Latching relay	✓	✓	24V	2x150W	090 899 240



Socket for relay



Pos 1



Pos 2



Pos 3

Type	Poled, for micro relay	Poled, for mini relay	Material: Plastic	Blade receptive	Mounting bracket	Can be linked together	Pos	Article No.
Socket for relay	5		✓	2 x 6,3 x 0,8 mm 3 x 4,8 x 0,8 mm	Ø 5,5 mm	✓	1	090 295 045
Socket for relay		9	✓	5 x 6,3 x 0,8mm 4 x 2,8 x 0,6 mm	Ø 5,5 mm	✓	2	090 290 008
Socket for relay		9	✓	2 x 9,5 x 1,2mm 3 x 6,3 x 0,8 mm 4 x 2,8 x 0,6 mm	Ø 5,5 mm	✓	3	090 295 005

Spare parts

Blade receptacle, locking lance, uninsulated, 1,0 - 2,5 mm <sup>2</sup> Cable: 1,0 - 2,5 mm <sup>2</sup> 4,8 x 0,8 mm	✓			099 852 104
Blade receptacle, locking lance, uninsulated, 1,5-2,5 mm <sup>2</sup> Cable: 1,5-2,5 mm <sup>2</sup> 6,3 x 0,8 mm	✓			099 852 108
Blade receptacle without lock, uninsulated, 9,5 x 1,1 mm Cable: 4,0-6,0 mm <sup>2</sup>	✓			099 852 110



For turn switches	Poled	Material: Plastic	Suitable for	For blade receptive	Article No.
✓	9	✓	083 862 001/002/ 004/011/052/054/073	6 x 6,3 x 0,8 mm	<b>099 852 290</b>
				6,3 x 0,8 mm/1,5 - 2,5 mm <sup>2</sup>	<b>099 852 108</b>
				2,8 x 0,8 mm/0,25-0,75 mm <sup>2</sup>	<b>099 852 101</b>

### Multisocket for head lights



Pos 1

For head Consumptions	With blade receptacle	Without blade receptacle	Pos	Article No.
H4	8,0 x 0,8 mm		1	<b>099 855 280</b>

#### Spare parts

Pin receptacle with locking lance	8,0 x 0,8 mm/1,5 - 2,5 mm <sup>2</sup>	<b>099 852 218</b>
-----------------------------------	--	--------------------

# FUSES

---



Glass fuses



ISO Norm	Type	Brass caps, nickel plated	Ø 5 x 20 mm	Consumption		Article No.
DIN 41661	Glass fuse, quick	✓	✓	15A		099 835 115

Mini blade fuses FK1

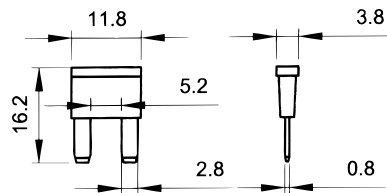
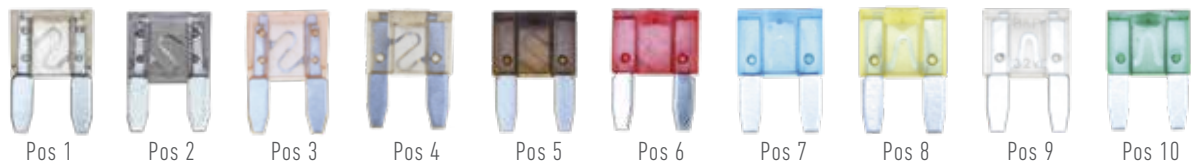

ISO Norm	Colour		Consumption	Packing unit	Pos	Article No.
DIN 72581/3F	Grey		2 A	25 pcs	1	099 837 302
DIN 72581/3F	Violet		3 A	25 pcs	2	099 837 303
DIN 72581/3F	Pink		4 A	25 pcs	3	099 837 304
DIN 72581/3F	Beige		5 A	25 pcs	4	099 837 305
DIN 72581/3F	Brown		7,5 A	25 pcs	5	099 837 307
DIN 72581/3F	Red		10 A	25 pcs	6	099 837 310
DIN 72581/3F	Blue		15 A	25 pcs	7	099 837 315
DIN 72581/3F	Yellow		20 A	25 pcs	8	099 837 320
DIN 72581/3F	White		25 A	25 pcs	9	099 837 325
DIN 72581/3F	Green		30 A	25 pcs	10	099 837 330

### Mini fuses with LED FK1

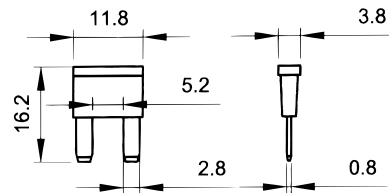
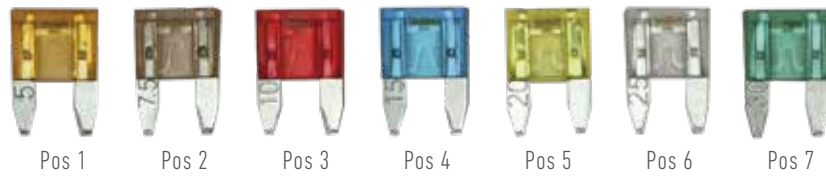

Colour		Consumption	LED shines if the fuse is blown	Max voltage	Packing unit	Pos	Article No.
Brown		7,5 A	✓	32V	10 pcs	2	<b>099 837 407</b>
Red		10 A	✓	32V	10 pcs	3	<b>099 837 410</b>
Blue		15 A	✓	32V	10 pcs	4	<b>099 837 415</b>
Yellow		20 A	✓	32V	10 pcs	5	<b>099 837 420</b>
Transparent		25 A	✓	32V	10 pcs	6	<b>099 837 425</b>
Green		30 A	✓	32V	10 pcs	7	<b>099 837 430</b>

### Fuse holder FK1



Type	Max. Consumption	Connecting cable	Article No.
Fuse holder FK1 for mini fuses	30	2,5 mm <sup>2</sup>	<b>099 841 034</b>

### Flat blade fuse FK2

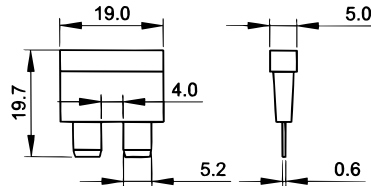

ISO Norm	Colour		Consumption	Packing unit	Pos	Article No.
DIN 72581/3C	Black		1 A	50 pcs	1	099 837 001
DIN 72581/3C	Grey		2 A	50 pcs	2	099 837 002
DIN 72581/3C	Violet		3 A	50 pcs	3	099 837 003
DIN 72581/3C	Pink		4 A	50 pcs	4	099 837 004
DIN 72581/3C	Beige		5 A	50 pcs	5	099 837 005
DIN 72581/3C	Brown		7,5 A	50 pcs	6	099 837 007
DIN 72581/3C	Red		10 A	50 pcs	7	099 837 010
DIN 72581/3C	Blue		15 A	50 pcs	8	099 837 015
DIN 72581/3C	Yellow		20 A	50 pcs	9	099 837 020
DIN 72581/3C	Transparent		25 A	50 pcs	10	099 837 025
DIN 72581/3C	Green		30 A	50 pcs	11	099 837 030
DIN 72581/3C	Amber		40 A	50 pcs	12	099 837 040

Flat blade fuse with LED FK2

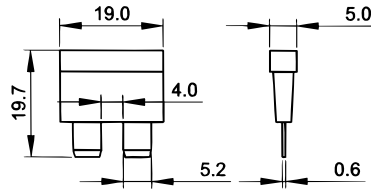
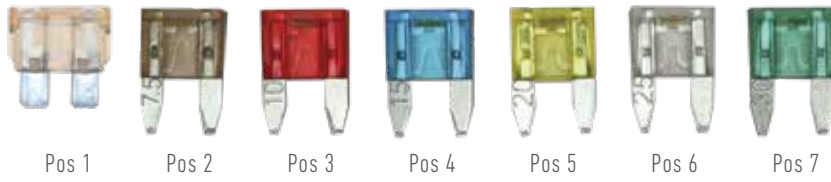

Colour		Consumption	LED shines if the fuse is blown	Max voltage	Packing unit	Pos	Article No.
Beige		5 A	✓	32V	10 pcs	1	<b>099 837 105</b>
Brown		7,5 A	✓	32V	10 pcs	2	<b>099 837 107</b>
Red		10 A	✓	32V	10 pcs	3	<b>099 837 110</b>
Blue		15 A	✓	32V	10 pcs	4	<b>099 837 115</b>
Yellow		20 A	✓	32V	10 pcs	5	<b>099 837 120</b>
Green		30 A	✓	32V	10 pcs	7	<b>099 837 130</b>

### Fuse holder FK2



Connecting cable	Max. A	Article No.
Amber 2,5 mm <sup>2</sup>	30 A	099 841 185

### Fuse holder FK2



Pos 1



Pos 2



Pos 3



Pos 4

Type	With flat pin terminal	Plastic housing	Max voltage	Max A	Pos	Article No.
Fuse holder FK2	6,3 x 0,8 mm	✓	32V	40 A	1	099 841 111
Fuse holder FK2	6,3 x 0,8 mm	✓	32V	40 A	2	099 841 030

#### Spare parts

Cover	3	099 841 112
Fastening plate	4	099 841 113



Fuse holder FK2

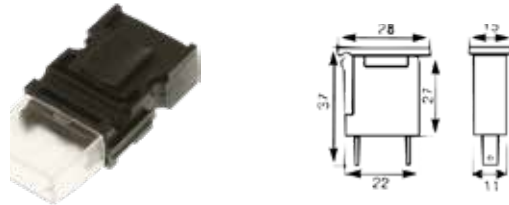

Plastic housing	With cover and crimp contacts for cable	Article No.
✓	1,5 mm <sup>2</sup> - 2,5 mm <sup>2</sup>	099 841 120

Fuse box FK2

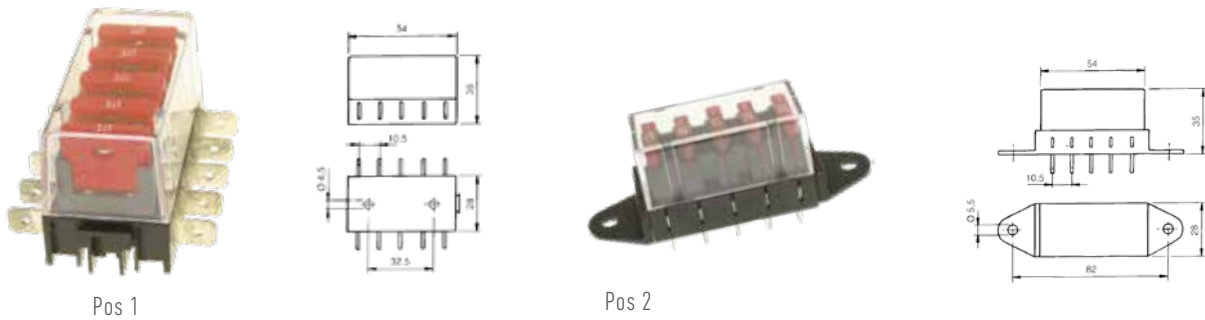

ISO Norm	With flat pin terminal	Incl. fuses	Plastic housing	Transparent cover	With	Pos	Article No.
DIN 72 581/3C	6,3 x 0,8 mm	✓	✓	✓	5 x 10 A	1	099 841 055
DIN 72 581/3C	6,3 x 0,8 mm	✓	✓	✓	5 x 10 A	2	099 841 065

### Fuse box FK2



Water protected  
2 out- and input with silver plated pins

ISO Norm	Pole	L x B x H	With flat pin terminal	Plastic housing	Transparent cover	Article No.
DIN 40 050	2	52 x 28 x 43 mm	6,3 x 0,8 mm	✓	✓	099 841 072
DIN 40 050	8	148 x 28 x 43 mm	6,3 x 0,8 mm	✓	✓	099 841 088

#### Spare parts

Double pole bridge	099 849 975
Socket for 099 841 086	099 849 963
Socket for 099 841 088	099 849 964

### Fuse with extra outlet

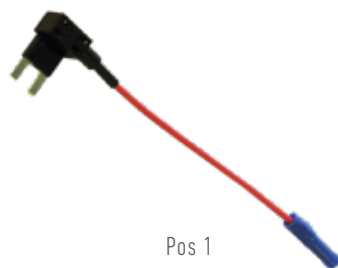

Pos 1







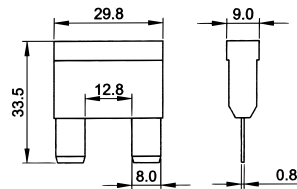

Pos 2

Mounting	Suitable for	Pos	Article No.
In fuse holder	FK1	1	099 841 206
In fuse holder	FK2	2	099 841 211

Maxi blade fuses



ISO Norm	Colour		Consumption	Packing unit	Pos	Article No.
DIN 72581/3E	Yellow		20 A	10 pcs	1	<b>099 837 220</b>
DIN 72581/3E	Green		30 A	10 pcs	2	<b>099 837 230</b>
DIN 72581/3E	Amber		40 A	10 pcs	3	<b>099 837 240</b>
DIN 72581/3E	Red		50 A	10 pcs	4	<b>099 837 250</b>
DIN 72581/3E	Blue		60 A	10 pcs	5	<b>099 837 260</b>
DIN 72581/3E	White		80 A	10 pcs	6	<b>099 837 280</b>
DIN 72581/3E	Violet		100 A	10 pcs	7	<b>099 837 300</b>

Fuse links

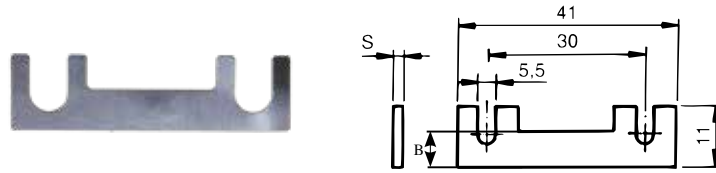

ISO Norm	S	B	Consumption	Packing unit	Article No.
DIN 72 581	0,25 mm	4,0 mm	30 A	10 pcs	099 838 330
DIN 72 581	0,20 mm	6,0 mm	40 A	10 pcs	099 838 340
DIN 72 581	0,40 mm	6,0 mm	50 A	10 pcs	099 838 350
DIN 72 581	0,50 mm	6,0 mm	80 A	10 pcs	099 838 380
DIN 72 581	0,70 mm	6,0 mm	100 A	10 pcs	099 838 310

Spare parts

Fuse holder	099 838 002
-------------	-------------







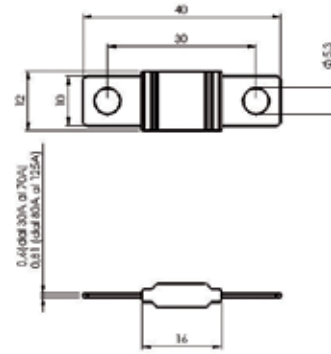
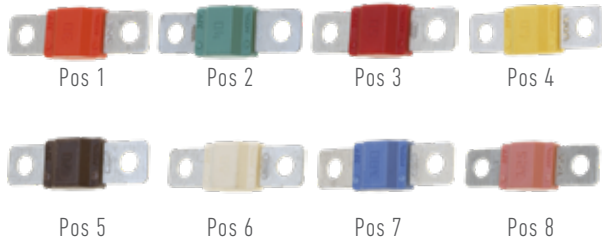

Fuse holder



For fuse-strips/Medival	Max. Consumption	Article No.
✓	125 A	099 838 002

Fuse links, Midifuse



Colour		Consumption	Pos	Article No.
Amber		30 A	1	099 838 130
Green		40 A	2	099 838 140
Red		50 A	3	099 838 150
Yellow		60 A	4	099 838 160
Brown		70 A	5	099 838 170
White		80 A	6	099 838 180
Blue		100 A	7	099 838 191
Pink		125 A	8	099 838 192

### Fuse links, Megafuse

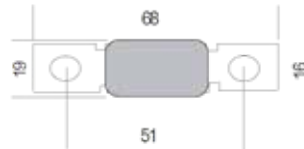

Colour		Consumption	Pos	Article No.
Yellow		100 A	1	099 838 710
Green		125 A	2	099 838 712
Amber		150 A	3	099 838 715
White		175 A	4	099 838 717
Blue		200 A	5	099 838 720
Beige		225 A	6	099 838 722
Pink		250 A	7	099 838 725
<b>Spare parts</b>				
Fuse holder				099 841 630

### Fuse holder for Megaval



For Megaval fuses	Supplied without fuse	Dimension	Hole distance	Operation voltage	Max. Consumption	Article No.
099 838 610/612/615/617/620/622/625	✓	119 x 42 x 39 mm	101 mm	32 V	250 A	099 841 630

Fuse links

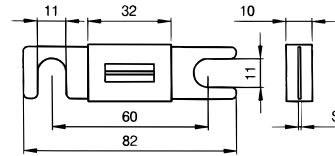

ISO Norm	S	Consumption	With insulated ceramic body	Packing unit	Article No.
DIN 43 560/1	0,65 mm	50 A	✓	5 pcs	099 839 550
DIN 43 560/1	1,00 mm	80 A	✓	5 pcs	099 839 580
DIN 43 560/1	0,50 mm	100 A	✓	5 pcs	099 839 600
DIN 43 560/1	0,80 mm	125 A	✓	5 pcs	099 839 625
DIN 43 560/1	1,00 mm	160 A	✓	5 pcs	099 839 660
DIN 43 560/1	0,80 mm	200 A	✓	5 pcs	099 839 700
DIN 43 560/1	0,50 mm	250 A	✓	5 pcs	099 839 750
DIN 43 560/1	0,80 mm	300 A	✓	5 pcs	099 839 800
DIN 43 560/1	1,00 mm	425 A	✓	5 pcs	099 839 925
DIN 43 560/1	1,00 mm	500 A	✓	5 pcs	099 839 950

### Fuse links



ISO Norm	S	B	Consumption	Packing unit	Article No.
DIN 43 560	0,60 mm	2,50 mm	50 A	10 pcs	<b>099 839 050</b>
DIN 43 560	1,00 mm	3,00 mm	80 A	10 pcs	<b>099 839 080</b>
DIN 43 560	0,50 mm	2,00 mm	100 A	10 pcs	<b>099 839 100</b>
DIN 43 560	0,40 mm	4,80 mm	160 A	10 pcs	<b>099 839 160</b>
DIN 43 560	0,50 mm	4,80 mm	200 A	10 pcs	<b>099 839 200</b>
DIN 43 560	0,60 mm	4,80 mm	250 A	10 pcs	<b>099 839 250</b>

### Fuse holder



Connection	Operation voltage	Max. Consumption	Base isolation material according to	Article No.
Screw terminal	80 V	425 A	DIN 7708/1	<b>099 841 040</b>

#### Spare parts

Suitable for: 099839550/580/600/625/660/700/750/800/855/925/950/050/080/100/125/160/200/250



### Compact main fuse

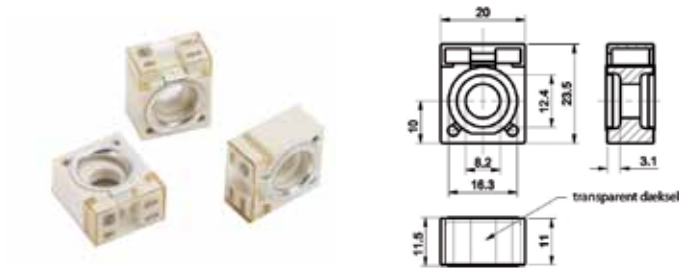

With transparent cover for visual inspection of melting element

Suitable for lifts and cranes	Operation voltage	Consumption	Article No.
IP56	58 V	150 A	<b>099 831 150</b>
IP56	58 V	175 A	<b>099 831 175</b>
IP56	58 V	200 A	<b>099 831 200</b>
IP56	58 V	250 A	<b>099 831 250</b>
IP56	58 V	300 A	<b>099 831 300</b>



# BLAD RECEPTACLES & TERMINALS

---



### Pin receptacle



Brass - tin-plated

Colour		W x H	Conductor cross-section	Packing unit	Article No.
Red		2,8 x 0,8 mm	0,5-1,0 mm <sup>2</sup>	50 pcs	<b>099 851 001</b>
Red		4,8 x 0,8 mm	0,5-1,0 mm <sup>2</sup>	50 pcs	<b>099 853 004</b>
Blue		4,8 x 0,8 mm	1,5-2,5 mm <sup>2</sup>	50 pcs	<b>099 851 005</b>
Red		6,3 x 0,8 mm	0,5-1,0 mm <sup>2</sup>	50 pcs	<b>099 853 007</b>
Blue		6,3 x 0,8 mm	0,5-2,5 mm <sup>2</sup>	50 pcs	<b>099 853 008</b>
Yellow		6,3 x 0,8 mm	4,0-6,0 mm <sup>2</sup>	50 pcs	<b>099 853 009</b>
Yellow		10,0 x 1,1 mm	4,0-6,0 mm <sup>2</sup>	50 pcs	<b>099 853 015</b>

### Pin receptacle branch



Brass - tin-plated

Colour		W x H	Conductor cross-section	Packing unit	Article No.
Red		6,3 x 0,8 mm	0,5-1,0 mm <sup>2</sup>	50 pcs	<b>099 853 037</b>
Blue		6,3 x 0,8 mm	1,5-2,5 mm <sup>2</sup>	50 pcs	<b>099 853 038</b>

### Pin receptacle, full insulated





Brass - tin-plated

Colour		W x H	Conductor cross-section	Packing unit	Article No.
Red		6,3 x 0,8 mm	0,5-1,0 mm <sup>2</sup>	50 pcs	<b>099 853 040</b>
Blue		6,3 x 0,8 mm	1,5-2,5 mm <sup>2</sup>	50 pcs	<b>099 853 041</b>
Yellow		6,3 x 0,8 mm	4,0-6,0 mm <sup>2</sup>	50 pcs	<b>099 853 042</b>

### Pin terminal





Tin, bronze

Colour		D	Conductor cross-section	Packing unit	Article No.
Red		Ø 4,0 mm	0,5-1,0 mm <sup>2</sup>	50 pcs	<b>099 853 053</b>
Blue		Ø 4,0 mm	1,5-2,5 mm <sup>2</sup>	50 pcs	<b>099 851 054</b>
Blue		Ø 5,0 mm	1,5-2,5 mm <sup>2</sup>	50 pcs	<b>099 851 055</b>

### Pin terminal





Brass - tin-plated

Colour		D	Conductor cross-section	Packing unit	Article No.
Red		Ø 4,0 mm	0,5-1,0 mm <sup>2</sup>	50 pcs	<b>099 853 063</b>
Blue		Ø 4,0 mm	1,5-2,5 mm <sup>2</sup>	50 pcs	<b>099 851 064</b>
Blue		Ø 5,0 mm	1,5-2,5 mm <sup>2</sup>	50 pcs	<b>099 851 065</b>

### Wire pin sleeve



Copper - tin-plated. Full insulated

Colour		D	Conductor cross-section	Packing unit	Article No.
Red		Ø 1,8 mm	0,5-1,0 mm <sup>2</sup>	50 pcs	<b>099 851 170</b>
Blue		Ø 1,8 mm	1,5-2,5 mm <sup>2</sup>	50 pcs	<b>099 851 171</b>
Yellow		Ø 1,8 mm	4,0-6,0 mm <sup>2</sup>	50 pcs	<b>099 851 172</b>

### Butt connector











Copper - tin-plated

Colour		Conductor cross-section	Packing unit	Article No.
Red		0,5-1,0 mm <sup>2</sup>	50 pcs	099 851 080

### Ring terminal



Copper - tin-plated

Colour		D	Conductor cross-section	Packing unit	Article No.
Red		Ø 4,3 mm	0,5-1,0 mm <sup>2</sup>	50 pcs	099 853 104
Blue		Ø 4,3 mm	1,5-2,5 mm <sup>2</sup>	50 pcs	099 853 124
Blue		Ø 5,3 mm	1,5-2,5 mm <sup>2</sup>	50 pcs	099 853 125
Blue		Ø 6,5 mm	1,5-2,5 mm <sup>2</sup>	50 pcs	099 853 126
Blue		Ø 8,4 mm	1,5-2,5 mm <sup>2</sup>	50 pcs	099 853 128
Blue		Ø 10,5 mm	1,5-2,5 mm <sup>2</sup>	50 pcs	099 853 130
Yellow		Ø 6,5 mm	4,0-6,0 mm <sup>2</sup>	50 pcs	099 853 146
Yellow		Ø 8,4 mm	4,0-6,0 mm <sup>2</sup>	50 pcs	099 853 148

### Crimp splice

	<p>Insert wire into crimp barrel</p>	<p>Crimp splice covered with adhesive shrinkable hose waterproof and weather resisting, Extra sealing and insulating not necessary.</p>
	<p>Crimp the crimp barrel</p>	<p>High strain relief by tight connection with wire insulation Temperature range: -55°C - +125°C Crimp splices meet requirements acc. <b>DIN 46234</b> Material: shrinkable Polyamide</p>
	<p>Heat shrinkable hose until tubing re-covers and adhesive melts and flows</p>	<p><b>Application index:</b> Automotive technic; electrical connections in humid rooms; outside illumination; alarm systems; tractors; earth moving vehicles boat electric</p>

### Crimp splice - blade receptacle



Copper - tin-plated

Colour		W x H	Conductor cross-section	Article No.
Red		6,3 x 0,8 mm	0,5-1,0 mm <sup>2</sup>	<b>099 851 812</b>
Blue		6,3 x 0,8 mm	1,5-2,5 mm <sup>2</sup>	<b>099 851 813</b>

### Crimp splice - blade terminal



Copper - tin-plated

Colour		W x H	Conductor cross-section	Article No.
Blue		6,3 x 0,8 mm	1,5-2,5 mm <sup>2</sup>	<b>099 851 824</b>

### Crimp splice - ring terminal



Copper - tin-plated

Colour		D	Conductor cross-section	Article No.
Yellow		∅ 6,5 mm	4,0-6,0 mm <sup>2</sup>	099 851 756
Yellow		∅ 8,4 mm	4,0-6,0 mm <sup>2</sup>	099 851 858

### Cable terminal



Colour		Conductor cross-section	Article No.
White		0,5 mm <sup>2</sup>	999 851 051
Lightblue		0,75 mm <sup>2</sup>	999 851 076
Black		1,5 mm <sup>2</sup>	999 851 151
Grey		2,5 mm <sup>2</sup>	999 851 251
Amber		4,0 mm <sup>2</sup>	999 851 401

### Crimp splice - butt connector



Copper - tin-plated

Minimum shrink temperature: 110 °C

Working temperature: -55 C to 125 ° C



Colour		Conductor cross-section	Article No.
Red		0,5-1,0 mm <sup>2</sup>	099 851 881
Blue		1,5-2,5 mm <sup>2</sup>	099 851 882
Yellow		4,0-6,0 mm <sup>2</sup>	099 851 883



## Soldering connector



Soldering and insulating in one work process  
for low temperature applications (up to + 125°C)

Colour		Conductor cross-section	Solder ring with integrated flow medium	Thermoplastic joint	Article No.
Transparent		0,3-0,8 mm <sup>2</sup>	✓	✓	099 851 984
Blue		1,5-2,5 mm <sup>2</sup>	✓	✓	099 851 986

## Pin receptacle with locking lance



W x H	Conductor cross-section	Loch	Material	Article No.
2,8 x 0,8 mm	0,25-0,75 mm <sup>2</sup>	✓	Brass - tin-plated	099 852 101
4,8 x 0,8 mm	0,5-2,5 mm <sup>2</sup>	✓	Brass - tin-plated	099 852 104
9,5 x 1,1 mm	4,0-6,0 mm <sup>2</sup>		Brass - tin-plated	099 852 110
6,3 x 0,8 mm	0,5-1,0 mm <sup>2</sup>	✓	Brass	099 852 107
6,3 x 0,8 mm	1,5-2,5 mm <sup>2</sup>	✓	Brass	099 852 108
6,3 x 0,8 mm	4,0-6,0 mm <sup>2</sup>	✓	Brass	099 852 109

## Pin receptacle with locking lance



W x H	Conductor cross-section	Material	Load- carrying capacity of current	Allowable total temperature	Article No.
8,0 x 0,8 mm	1,5-2,5mm <sup>2</sup>	Brass			099 852 118

### Pin receptacle



Pos 1



Pos 2

W x H	Conductor cross-section	Material	Pos	Article No.
6,3 x 0,8 mm	0,5-1,0mm <sup>2</sup>	Brass	1	<b>099 852 116</b>
6,3 x 0,8 mm	0,5-2,5mm <sup>2</sup>	Brass	2	<b>099 852 117</b>

### Pin terminal



Pos 1



Pos 2



Pos 3



Pos 4

Type	W x H	Conductor cross-section	Material	Pos	Article No.
With locking lance	6,3 x 0,8 mm	1,0-1,5 mm <sup>2</sup>	Brass	1	<b>099 852 126</b>
With locking lance	6,3 x 0,8 mm	1,5-2,5 mm <sup>2</sup>	Brass	1	<b>099 852 125</b>
With locking lance	6,3 x 0,8 mm	4,0-6,0 mm <sup>2</sup>	Brass	2	<b>099 852 124</b>
	6,3 x 0,8 mm	0,5-1,0 mm <sup>2</sup>	Brass - tin-plated	3	<b>099 852 127</b>
	6,3 x 0,8 mm	1,5-2,5 mm <sup>2</sup>	Brass - tin-plated	4	<b>099 852 130</b>

### Double blade connector



W x H	Material	Article No.
6,3 x 0,8 mm	Brass	099 852 233

### Pin receptacle + branch



W x H	Conductor cross-section	Material	Article No.
6,3 x 0,8 mm	0,5-1,5 mm <sup>2</sup>	Brass	099 852 138

### Receptacle



Pos 1



Pos 2

Ø	Conductor cross-section	Material	Pos	Article No.
3,5 mm	1,0-2,5 mm <sup>2</sup>	Brass - tin-plated	1	099 852 255

Insulation sleeve



For blade receptacle with locking lance (6,3 x 0,8 mm)	For blade terminal + blade receptacle	Material	Pos	Article No.
✓		Polyethylen	1	099 852 286
	✓	Polyethylen	2	099 852 288

Soldered ring terminal

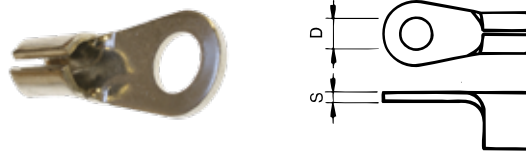

Conductor cross-section	S	D	Material	Surface: Lead-tin-alloy	Article No.
10 mm <sup>2</sup>	1,5 mm	8,4 mm	Copper	✓	099 852 335
16 mm <sup>2</sup>	1,8 mm	8,4 mm	Copper	✓	099 852 345
16 mm <sup>2</sup>	1,8 mm	10,5 mm	Copper	✓	099 852 346
25 mm <sup>2</sup>	2,0 mm	10,5 mm	Copper	✓	099 852 356

Terminal

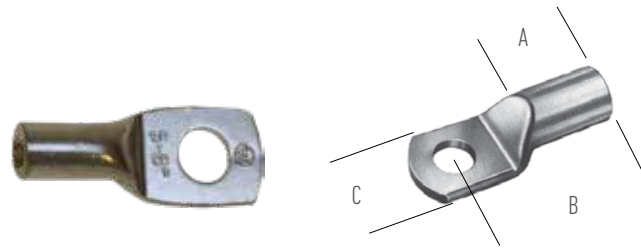

Terminals for crimping

ISO Norm	Conductor cross-section	Ø	Hole Ø	A	B	C	Copper galvanic tinned	Article No.
DIN EN 13600	6 mm <sup>2</sup>	3,7 mm	5,3 mm	8 mm	19 mm	10 mm	✓	999 854 021
DIN EN 13600	6 mm <sup>2</sup>	3,7 mm	6,4 mm	8 mm	21 mm	11 mm	✓	999 854 022
DIN EN 13600	6 mm <sup>2</sup>	3,7 mm	8,4 mm	8 mm	23 mm	14 mm	✓	999 854 023
DIN EN 13600	6 mm <sup>2</sup>	3,7 mm	10,5 mm	8 mm	25 mm	15 mm	✓	999 854 024
DIN EN 13600	10 mm <sup>2</sup>	4,3 mm	5,3 mm	10 mm	20 mm	10 mm	✓	999 854 205
DIN EN 13600	10 mm <sup>2</sup>	4,3 mm	6,4 mm	10 mm	22 mm	10 mm	✓	999 854 206
DIN EN 13600	10 mm <sup>2</sup>	4,3 mm	8,4 mm	10 mm	25 mm	15 mm	✓	999 854 207
DIN EN 13600	10 mm <sup>2</sup>	4,3 mm	10,5 mm	10 mm	28 mm	18 mm	✓	999 854 208
DIN EN 13600	16 mm <sup>2</sup>	5,4 mm	6,4 mm	11 mm	22 mm	10 mm	✓	999 854 211
DIN EN 13600	16 mm <sup>2</sup>	5,4 mm	8,4 mm	11 mm	27 mm	15 mm	✓	999 854 212
DIN EN 13600	16 mm <sup>2</sup>	5,4 mm	10,5 mm	11 mm	29 mm	18 mm	✓	999 854 213
DIN EN 13600	25 mm <sup>2</sup>	6,9 mm	6,4 mm	13 mm	27 mm	14 mm	✓	999 854 215
DIN EN 13600	25 mm <sup>2</sup>	6,9 mm	8,4 mm	13 mm	29 mm	15 mm	✓	999 854 216
DIN EN 13600	25 mm <sup>2</sup>	6,9 mm	10,5 mm	13 mm	32 mm	18 mm	✓	999 854 217
DIN EN 13600	25 mm <sup>2</sup>	6,9 mm	13,0 mm	13 mm	34 mm	20 mm	✓	999 854 218
DIN EN 13600	35 mm <sup>2</sup>	8,3 mm	6,4 mm	16 mm	32 mm	17 mm	✓	999 854 220
DIN EN 13600	35 mm <sup>2</sup>	8,3 mm	8,4 mm	16 mm	33 mm	17 mm	✓	999 854 221
DIN EN 13600	35 mm <sup>2</sup>	8,3 mm	10,5 mm	16 mm	36 mm	18 mm	✓	999 854 222
DIN EN 13600	35 mm <sup>2</sup>	8,3 mm	12,0 mm	16 mm	37 mm	20 mm	✓	999 854 223
DIN EN 13600	50 mm <sup>2</sup>	9,6 mm	8,4 mm	18 mm	37 mm	19 mm	✓	999 854 225
DIN EN 13600	50 mm <sup>2</sup>	9,6 mm	10,5 mm	18 mm	39 mm	20 mm	✓	999 854 226
DIN EN 13600	50 mm <sup>2</sup>	9,6 mm	13,0 mm	18 mm	41 mm	23 mm	✓	999 854 227
DIN EN 13600	70 mm <sup>2</sup>	11,5 mm	10,5 mm	21 mm	43 mm	23 mm	✓	999 854 231
DIN EN 13600	70 mm <sup>2</sup>	11,5 mm	13,0 mm	21 mm	44 mm	23 mm	✓	999 854 232
DIN EN 13600	95 mm <sup>2</sup>	13,5 mm	10,5 mm	26 mm	47 mm	23 mm	✓	999 854 236
DIN EN 13600	95 mm <sup>2</sup>	13,5 mm	13,0 mm	26 mm	47 mm	23 mm	✓	999 854 237

### Terminal

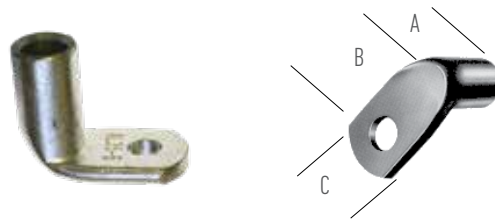

ISO Norm	Conductor cross-section	∅	Hole ∅	A	B	C	Copper galvanic tinned	Article No.
DIN EN 13600	16 mm <sup>2</sup>	5,4 mm	6,5 mm	11 mm	14 mm	10 mm	✓	999 854 311
DIN EN 13600	35 mm <sup>2</sup>	8,3 mm	6,5 mm	17 mm	16 mm	15 mm	✓	999 854 320
DIN EN 13600	35 mm <sup>2</sup>	8,3 mm	8,4 mm	17 mm	18 mm	15 mm	✓	999 854 321
DIN EN 13600	50 mm <sup>2</sup>	9,6 mm	10,5 mm	20 mm	21 mm	17 mm	✓	999 854 326
DIN EN 13600	70 mm <sup>2</sup>	11,5 mm	10,5 mm	22 mm	22 mm	20 mm	✓	999 854 331

### Blade connector



Plug type	Poled	Connection	L x B x H	Cable	>2,5 mm <sup>2</sup>	Trans-parent	Pos	Article No.
Blade connector		Flat pin terminal 6,3 x 0,8	48 x 12 x 6 mm			✓	1	099 855 403
Blade connector		Flat pin terminal 6,3 x 0,8	54 x 21 x 7 mm			✓	2	099 855 405
Flexible cable connector	12	Screw terminals		2,5 mm <sup>2</sup>			3	099 855 416
Flexible cable connector	12	Screw terminals		6,0 mm <sup>2</sup>				099 855 418
Flexible cable connector	12	Screw terminals		10,0mm <sup>2</sup>				099 855 419
End terminal, single					✓		4	999 855 417
End terminal, double					✓		5	999 855 427

Plug housing

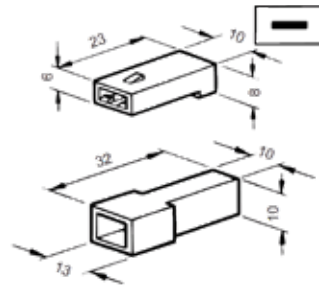

For blade terminal	For blade receptacle	With locking lance	Article No.
	✓	✓	099 855 517
✓		✓	099 855 516

Plug housing

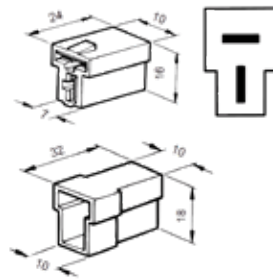

For blade terminal	For blade receptacle	With locking lance	Article No.
	✓	✓	099 855 507
✓		✓	099 855 508

Plug housing

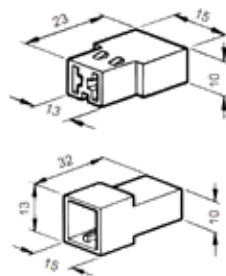

For blade terminal	For blade receptacle	With locking lance	Article No.
	✓	✓	099 855 523
✓		✓	099 855 524



Plug housing

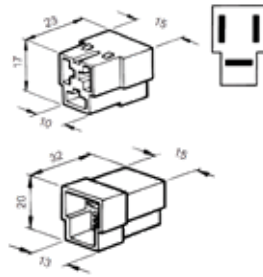

For blade terminal	For blade receptacle	With locking lance	Article No.
	✓	✓	099 855 531
✓		✓	099 855 530

Plug housing

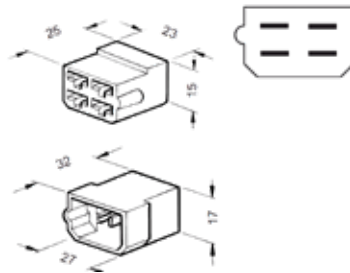

For blade terminal	For blade receptacle	With locking lance	Article No.
	✓	✓	099 855 503
✓		✓	099 855 106

Plug housing

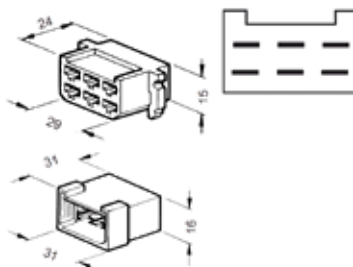

For blade terminal	For blade receptacle	With locking lance	Article No.
	✓	✓	099 855 512
✓		✓	099 855 511

Plug housing

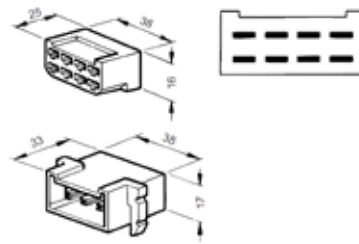

Poled	For blade receptacle	With locking lance	Article No.
	✓	✓	<b>099 855 577</b>
✓		✓	<b>099 855 578</b>

# OPERATION UNITS

---



### Operation unit



### Complete operation unit

Mounting	Coil cable	Colour	Heating cable	Pos.	Article No.
For installation		Yellow	24V (pre-mounted)	1	<b>093 960 100</b>
Bracket fitted (incl.)		Yellow		2	<b>093 960 200</b>
Bracket fitted (incl.)	4-core	Yellow		3	<b>093 962 400</b>
Bracket fitted (incl.)	5-core	Yellow	24V (pre-mounted)	4	<b>093 962 500</b>

## Magnet for operation unit



Type	Article No.
Magnet Ø75/Ø6,0 hole in the middle on 6,0 mm. Can be used for all	098 299 809

## Equivalent switch for operation unit



Type	For operation unit	Colour	Article No.
Equivalent switch NO	093 960 100 ... 500	Green	992 861 610

## Spare parts



Rubber cap for yellow operation unit 093 96x xxx	2	992 862 012
Heating cable 24V/5W for operation unit - Length 545 mm	3	093 865 124



# INVERTERS

---



DC TO AC POWER INVERTER 300 W



Supplied with cable with plug for cigarette lighter and battery loading tongs.  
 For optimal use and long life time, the inverter should be loaded with minimum 80% of the continuous power.  
 Do NOT cover the inverter's ventilation holes

	Power inverter 12V	Power inverter 24V	Article No.
<b>Power inverter 12V</b>			<b>959 020 312</b>
<b>Power inverter 24V</b>			<b>959 040 324</b>

Output waveform	MODIFY SINEWAVE	MODIFY SINEWAVE
Input voltage range	DC 10~15V (12V)	DC 20~30V (24V)
Input full load current	30A (12V)	15A (24V)
Standby input current	<0.6A (12V)	<0.5A (24V)
Output voltage (AC)	220V~240V	220V~240V
Output frequency	50Hz or 60Hz	50Hz or 60Hz
Continue output power	300W	300W
Peak output power	900W	900W
Efficiency	90%	90%
Battery low pre-alarm	10.5 ± 0.5V (12V)	21 ± 0.5V (24V)
Battery low shutdown	10 ± 0.5V (12V)	20 ± 0.5V (24V)
Thermal protect	60 ± 5 °C	60 ± 5 °C
Auto-operation fan (temperature or load)	YES	YES
Overload protect	YES	YES
Output short protect	YES	YES
Battery ex. 12V/24V protect	YES	YES
Battery polarity protect	YES (BY FUSE)	YES (BY FUSE)
Fuse	35A*1PC+15A*1PC (12V)	20A*1PC+10A*1PC (24V)
Dimension (L*W*H) mm	140*73*58 mm	140*73*58 mm
Weight	750g	750g
Approvals	CE, E4	CE, E4



DC TO AC POWER INVERTER 600 W

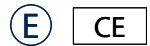

Supplied with cable with battery clamps.  
 For optimal use and long life time, the inverter should be loaded with minimum 80% of the continuous power.  
 Do NOT cover the inverter's ventilation holes

	Power inverter 12V	Power inverter 24V	Pos	Article No.
<b>Power inverter 12V</b>			<b>1</b>	<b>959 020 612</b>
<b>Power inverter 24V</b>			<b>2</b>	<b>959 040 624</b>

Output waveform	MODIFY SINEWAVE	MODIFY SINEWAVE
Input voltage range	DC 10~15V (12V)	DC 20~30V (24V)
Input full load current	60A (12V)	30A (24V)
Standby input current	<0.6A (12V)	<0.4A (24V)
Output voltage (AC)	220V~240V	220V~240V
Output frequency	50Hz or 60Hz	50Hz or 60Hz
Continue output power	600W	600W
Peak output power	1500W	1500W
Efficiency	85~90%	85~90%
Battery low pre-alarm	10.5 ± 0.5V (12V)	21 ± 0.5V (24V)
Battery low shutdown	10 ± 0.5V (12V)	20 ± 0.5V (24V)
Thermal protect	60 ± 5 °C	60 ± 5 °C
Auto-operation fan (temperature or load)	YES	YES
Overload protect	YES	YES
Output short protect	YES	YES
Battery ex. 12V/24V protect	YES	YES
Battery polarity protect	YES (BY FUSE)	YES (BY FUSE)
Fuse	25A*3PCS (12V)	15A*3PCS (24V)
Dimension (L*W*H) mm	190*113*62	190*113*62
Weight	1500g	1500g
Approvals	CE, E4	CE, E4

DC TO AC POWER INVERTER 1000 W



Pos 1



Pos 2

For optimal use and long life time, the inverter should be loaded with minimum 80% of the continuous power. Do NOT cover the inverter's ventilation holes

	Power inverter 12V	Power inverter 24V	Pos	Article No.
--	--------------------	--------------------	-----	-------------

<b>Power inverter 12V</b>			1	959 021 012
<b>Power inverter 24V</b>			1	959 041 024

Output waveform	MODIFY SINEWAVE	MODIFY SINEWAVE
Input voltage range	DC 10~15V (12V)	DC 20~30V (24V)
Input full load current	100A (12V)	50A (24V)
Standby input current	<0.6A (12V)	<0.5A (24V)
Output voltage (AC)	220V~240V	220V~240V
Output frequency	50Hz or 60Hz	50Hz or 60Hz
Continue output power	1000W	1000W
Peak output power	2400W	2400W
Efficiency	85~90%	85~90%
Battery low pre-alarm	10.5 ± 0.5V (12V)	21 ± 0.5V (24V)
Battery low shutdown	10 ± 0.5V (12V)	20 ± 0.5V (24V)
Thermal protect	60 ± 5°C	60 ± 5°C
Auto-operation fan (temperature or load)	YES	YES
Overload protect	YES	YES
Output short protect	YES	YES
Battery ex. 12V/24V protect	YES	YES
Battery polarity protect	YES (BY FUSE)	YES (BY FUSE)
Fuse	20A*6PCS (12V)	10A*6PCS (24V)
Dimension (L*W*H) mm	340*135*79	340*135*79
Weight	2500g	2500g
Approvals	CE, E4	CE, E4

**Spare parts**

Remote Control ON/OFF, 5000 mm cable	2	959 823 200
--------------------------------------	---	-------------

DC TO AC POWER INVERTER 1500 W

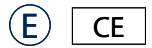

Pos 1



Pos 2

For optimal use and long life time, the inverter should be loaded with minimum 80% of the continuous power. Do NOT cover the inverter's ventilation holes

	Power inverter 12V	Power inverter 24V	Pos	Article No.
<b>Power inverter 12V</b>			1	959 021 512
<b>Power inverter 24V</b>			2	959 041 524

Output waveform	MODIFY SINEWAVE	MODIFY SINEWAVE
Input voltage range	DC 10~15V (12V)	DC 20~30V (24V)
Input full load current	150A (12V)	75A (24V)
Standby input current	<0.7A (12V)	<0.6A (24V)
Output voltage (AC)	220V~240V	220V~240V
Output frequency	50Hz or 60Hz	50Hz or 60Hz
Continue output power	1500W	1500W
Peak output power	3000W	3000W
Efficiency	85~90%	85~90%
Battery low pre-alarm	10.5 ± 0.5V (12V)	21 ± 0.5V (24V)
Battery low shutdown	10 ± 0.5V (12V)	20 ± 0.5V (24V)
Thermal protect	60 ± 5 °C	60 ± 5 °C
Auto-operation fan (temperature or load)	YES	YES
Overload protect	YES	YES
Output short protect	YES	YES
Battery ex. 12V/24V protect	YES	YES
Battery polarity protect	YES (BY FUSE)	YES (BY FUSE)
Fuse	25A*8PCS (12V)	15A*8PCS (24V)
Dimension (L*W*H) mm	400*135*79	400*135*79
Weight	3300g	3300g
Approvals	CE, E4	CE, E4

**Spare parts**

Remote Control ON/OFF, 5000 mm cable	2	959 823 200
--------------------------------------	---	-------------

DC TO AC POWER INVERTER 3000 W

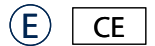

Pos 1



Pos 2

For optimal use and long life time, the inverter should be loaded with minimum 80% of the continuous power.  
Do NOT cover the inverter's ventilation holes

	Power inverter 12V	Power inverter 24V	Pos	Article No.
<b>Power inverter 12V</b>			<b>1</b>	<b>959 023 012</b>
<b>Power inverter 24V</b>			<b>1</b>	<b>959 043 024</b>

Output waveform	MODIFY SINEWAVE	MODIFY SINEWAVE
Input voltage range	DC 10~15V (12V)	DC 20~30V (24V)
Input full load current	300A (12V)	150A (24V)
Standby input current	<1A (12V)	<0.9A (24V)
Output voltage (AC)	220V~240V	220V~240V
Output frequency	50Hz or 60Hz	50Hz or 60Hz
Continue output power	3000W	3000W
Peak output power	6000W	6000W
Efficiency	85~90%	85~90%
Battery low pre-alarm	10.5 ± 0.5V (12V)	21 ± 0.5V (24V)
Battery low shutdown	10 ± 0.5V (12V)	20 ± 0.5V (24V)
Thermal protect	60 ± 5 °C	60 ± 5 °C
Auto-operation fan (temperature or load)	YES	YES
Overload protect	YES	YES
Output short protect	YES	YES
Battery ex. 12V/24V protect	YES	YES
Battery polarity protect	YES (BY FUSE)	YES (BY FUSE)
Fuse	25A*16PCS (12V)	15A*16PCS (24V)
Dimension (L*W*H) mm	400*135*79	400*135*79
Weight	5900g	5900g
Approvals	CE, E4	CE, E4

**Spare parts**

Remote Control ON/OFF, 5000 mm cable	2	<b>959 823 200</b>
--------------------------------------	---	--------------------

# REVERSING ALARM

---



Reverse gear alarm



Black polycarbonate housing with galvanized mounting bracket  
 Cycle 60/min  
 Distance between mountingholes : 22 mm ( hole Ø 5,2 mm )

IP Rating	Volume	Frequency range	Consumption	Operation voltage	Measure	Connection	Article No.
IP54	108 dB	2,6 kHz	10W	12/24V	58,8 x 37 mm	250 mm cable with Super Seal plug	<b>090 450 350</b>

# CONTACT ALLOCATION

---



**Contact allocation Super Seal plug 1 x 2 pol.**

		Colour	Description
	1	Brown	Ground
	2	Blue	Permanent power supply

**Contact allocation type 12V, 5 pol. plug**

		Colour	Description
	1	Yellow	Indicator
	2	Brown	Stop light
	3	Blue	Rear fog light
	4	Green	Position light
	5	Black	Ground

**Contact allocation ABS-EBS 24V, 5/7-pol ISO 7638**

		Colour	Description
	1	Red	Plus electrovalves
	2	Black	Plus electronics
	3	Yellow	Minus electronics
	4	Brown	Minus electro valves
	5	White	Warning device
	6	White-green	Data communication
	7	White-brown	Data communication

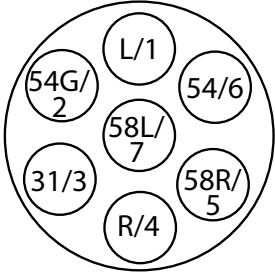

**Contact allocation N-type 12V, 7-pol. ISO 1724**

		Colour	Description
	L / 1	Yellow	Left hand direction indicator light
	54G / 2	Blue	Rear fog light
	31 / 3	White	Equipment ground
	R / 4	Green	Right hand direction indicator light
	58R / 5	Brown	Right hand rear position and marker lights, and license plate light 1)
	54 / 6	Red	Stop light
	58L / 7	Black	Left hand rear position and marker lights, and license plate light 1)

1) The license plate lamp must be connected in such a manner that no lamps of this illumination have common connection with contact 5 and 7.

**Contact allocation S-type 12V, 7-pol. ISO 3732**

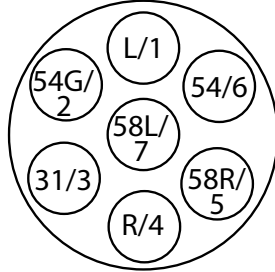
		Colour	Description
	L / 1	Yellow	Reversing light (yellow) 1)
	54G / 2		Reserved for future allocation
	31 / 3	White	Earth (white)
	R / 4	Green	Power supply (green)
	58R / 5		No allocation
	54 / 6	Red	Power supply, controlled by ignition switch
	58L / 7		Return for circuit to contact no. 6

58L/7 contact / socket receptacle. 58L/7 contact / connector - pin

1) Contact no. 3 of 7-pin/12V N-connector accord. to ISO 1724 is usually allocated as the return for this contact

**Contact allocation N-type 24V, - 7 pol. ISO 1185**

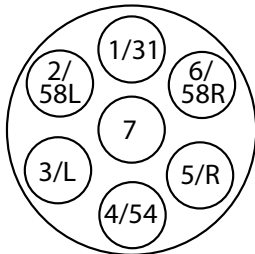
		Colour	Description
	1 / 31	White	Ground
	2 / 58L	Black	Position and marker lights, left <sup>1)</sup>
	3 / L	Yellow	Indicator light, left
	4 / 54	Red	Stop light
	5 / R	Green	Indicator light, right
	6 / 58R	Brown	Position and marker lights, right <sup>1)</sup>
	7	Blue	Aux2 / Braking control for trailers

<sup>1)</sup> The license plate must be connected so that no lights of this illumination have common connection with contact 2 and 6

**Contact allocation S-type 24V, 7 pol. ISO 3731**

		Colour	Description
	1 / 31	White	Ground for electronics (Ground for CAN)
	2	Black	No allocation ( CANH, Data Communication )
	3	Yellow	Reversing light
	4	Red	Permanent power supply
	5	Green	No allocation ( CANL, Data communication )
	6	Brown	Aux3 / Axle lift device
	7	Blue	Rear fog light

**Contact allocation AMP plug, 7pol.**

		Colour	Description
	1	White	Ground
	2	Green	Position lights
	3	Brown	Reversing light
	4	Yellow	Direction indicator light
	5	Red	Stop light
	6	Blue	Rear fog light
	7	-	-

**Contact allocation Ermax bayonet plug, 15 pol.**

		Colour	Description
	1	Black	Position and marker lights, left
	2	Yellow	Indicator light, left
	3	Red	Stop light
	4	White/Green	CANH, Data communication
	5	White	Ground
	6	Rosa	Reversing light
	7	White/ Black	Aux2 / Braking control for trailers
	8	White/Red	Ground for electronics ( Ground for CAN )
	9	Amber	Permanent power supply
	10	Blue	Rear fog light
	11	Grey	Aux1 / Brake wear sencor
	12	White/Brown	CANL / Data communication
	13	Brown	Position and marker lights, right
	14	White/Blue	Aux3 / Axel lifting device
	15	Green	Indicatorer Right

**Contact allocation 12V, 13 pol. ISO 11446**

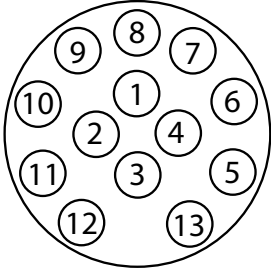
		Colour	Description
	1	Yellow	Left hand direction indicator light (yellow)
	2	Blue	Rear fog light (blue)
	3	White	Earth for contacts no. 1-8. 1)
	4	Green	Right hand direction indicator light
	5	Brown	Right hand rear position and marker lights, and license plate light 2)
	6	Red	Stop light
	7	Black	Left hand rear position and marker lights, and license plate light 2)
	8	Pink	Reversing light
	9	Amber	Power supply, permanent positive
	10	Grey	Power supply, controlled by ignition switch
	11	White-black	Earth for contact no. 10. 1)
	12		Trailer connection identification. In the plug the contact no.12 is connected to contact no. 3 to signal the truck whether a trailer is connected pulling.
	13	White-red	Earth for contact no. 9. 1)

1) All three earth cables must not be connected electrically conducting

2) The license-plate lamp must be connected in such a manner that no lamps of this illumination have a common connection with contact no. 5 and no. 7

**Contact allocation 24V, 15 pol. ISO 12098**

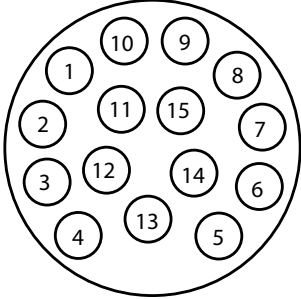
		Colour	Description
	1	Yellow	Indicator, left
	2	Green	Indicator, right
	3	Blue	Rear fog light
	4	White	Ground
	5	Black	Position and marker lights, left <sup>1)</sup>
	6	Brown	Position and marker lights, right <sup>1)</sup>
	7	Red	Stop lights
	8	Pink	Reversing light
	9	Amber	Permanent power supply
	10	Grey	Aux1 / Brake wear sensor
	11	White/Black	Aux2 / Braking control for trailers
	12	White/Blue	Aux3 / Axle lifting device
	13	White/Red	Ground for electronics ( Ground for CAN )
	14	White/Green	CANH / Data communication
	15	White/Brown	CANL / Data communication

<sup>1)</sup> The license plate illumination must be connected so that no lights of this illumination have a common connection with contract nr. 5 and nr. 7

August 2023 • Version 5.0



ERMAX A/S  
Vranderupvej 2 • DK-6000 Kolding  
Tel. +45 3969 6800 • [www.ermx.dk](http://www.ermx.dk)