

TRYKLUF

CYLINDRE • KOMPRESSORER • VENTILER • BETJENINGSBOKSE
LUFTTØRRERE • SPIRALSLANGER

Alt det, du lige
står og mangler

DIN LOKALE SAMARBEJDSPARTNER

BESKO

Member of the
 Aftermarket
Group

SE VORES
KURSER PÅ
BESKOAKADEMI.DK

**Er du klædt på til
fremtidens udfordringer?**

Lufttørrere	5 - 11
Kompressorer	12 - 15
Håndbremseventiler	16 - 17
4-Kreds beskyttelsesventiler	18 - 21
Relæventiler	22 - 24
Hæve- sænkeventiler	25 - 27
Anhængerstyreventiler	28
Anhængerbremseventiler	29 - 30
ALB-ventiler	31 - 39
Liftakselventiler	40 - 41
Hurtigudløserventiler	42 - 43
Løsnerventiler	44 - 47
Fodbremseventiler	48 - 50
Overstrømningsventiler	51
3/2, 4/2, 5/2-vejs ventiler	52 - 53
Gearskifteventiler	54
Sikkerhedsventiler	55
Trykbegrænsningsventiler	56 - 57
Trykregulatorer	58
Betjeningsbokse	59 - 60
ABS-ventiler	61 - 64
ABS tilbehør	65 - 68
EBS ventiler	69 - 72
ECAS-ELC-ventiler	73 - 74

ECAS-ELC-dele	75 - 76
Reguleringsventiler	77
Kontraventiler	78
Arbejdscyindre	79
Spærre-ventiler/cylindre	80
Førehusniveauventiler	81 - 82
Niveauventiler	83 - 87
Proportionalventiler	88
Magnetventiler	89 - 93
Stempelcylindre	94
Afspærrehaner	95
Membrancyindre	96 - 97
Fjederbremsecylindre	98 - 100
Tilbehør fjederbremse og membrancyindre	101 - 103
Trykluftbeholdere	104 - 105
Duomatic luftkoblinger	106 - 107
Trykluft-spiralslanger	108 - 113
Luftkoblinger	114 - 116
Lynfittings - standard	117 - 124
Lynfittings - plug-in	125 - 128
Lynfittings - sortiment	129 - 131
Konventionelle fittings	132 - 145
Plastrør og bremseslanger	146 - 147
Diverse	148 - 150
Alfabetisk oversigt	151

Scania Lastbil

Illustration	Beskrivelse	Bestillingsnr.
	3-serie (1-tårnet)	LA6711
	Filterpatron	T250W
	4-serie - 9,3 bar (1-tårnet)	432.410.083.7
	Filterpatron	T300W
	4-serie - 12,2 bar (1-tårnet)	78985
	Flange filterpatron	718685
	Blackbox	87347
	Varmelegeme	78150
	Filterpatron	78964

Volvo Lastbil

Illustration	Beskrivelse	Bestillingsnr.
	F7-F12 (1-tårnet)	267121SP
	Filterindsats	SK2767/5
	Bunddæksel	267125SP
	FH + FL (1-tårnet)	78990
	Filterpatron	78964
	Flange filterpatron	718685
	Blackbox	78703
	FH (1-tårnet)	LA8286
	Filterpatron	T250W
	FH (2-tårnet)	432.431.008.7
	Filterpatron	T250W

Volvo Lastbil

Illustration	Beskrivelse	Bestillingsnr.
	FL (1-tårnet)	71239
	Filterpatron	H71059

Volvo FH og FM version II, 2005 -->

Illustration	Beskrivelse	Bestillingsnr.
	Max tryk 13 bar	432.425.101.0
	Filterpatron	432.901.223.2

Mercedes/DAF/MAN Lastbil

Illustration	Beskrivelse	Bestillingsnr.
	1-tårnet	LA8234
	Filterpatron	T250W

Man Lastbil

Illustration	Beskrivelse	Bestillingsnr.
	1-tårnet	LA8211
	Filterpatron	T250W
	1-tårnet	LA8222
	Filterpatron	T250W

Daf Lastbil

Illustration	Beskrivelse	Bestillingsnr.
	1-tårnet	432.420.000.7
	Filterpatron	T250W
	2-tårnet	432.431.008.7
	Filterpatron	T250W

Tilbehør

Illustration	Beskrivelse	Bestillingsnr.
	Wabco skruefilter M39x1,5 forbedret olieudskilning	432.901.223.2
	Skruefilter M41X1,5	BA5376
	Skruefilter M39X1,5	BA5374
	Skruefilter R11/4X14mm	BA5375

Tilbehør

Illustration	Beskrivelse	Bestillingsnr.
	Filterpatron Haldex	93522
	Filterpatron Haldex	71034
	Filterpatron Bendix	SK2914-1
	Filterindsats Bendix	SK2767-5

Tilbehør



Illustration	Beskrivelse	Bestillingsnr.
	Filterindsats Wabco	432.406.920.2
	Lyddæmper M22x1,5	432.407.060.0
	Wabco lyddæmper snap tilslutning	432.407.070.0
	Wabco udluftningsfilter - M22x1,5	432.700.000.0

Kompressorer



Scania Lastbil

Illustration	Beskrivelse	Bestillingsnr.
	Serie 3	KZ642-2RM
	Pakning	1187211 11853056
	Serie 3	KZ996-2RM
	Pakning	1187211 1185306
	Serie 3 - 4	LP4814 AT
	Serie 3 - 4	LP4815 AT

Scania Lastbil

Illustration	Beskrivelse	Bestillingsnr.
	Serie 4	LP4957 AT
	Pakning	801547252
	Serie 4 + R	LK4941 AT

Volvo Lastbil

Illustration	Beskrivelse	Bestillingsnr.
	F10 - F12	KZ433-1RM
	O-ring	269067
	Pakning	1187211 1185306
	F12 - FL7 (Intercooler)	911.505.150.7
	O-ring	269067

Volvo Lastbil

Illustration	Beskrivelse	Bestillingsnr.
	FL 6-serie	LP3970AT
	O-ring	269067
	FL616 - FL619, FL7, F10, F12	LP4812AT
	O-ring	269067
	FL618	LP4813AT
	O-ring	269067
	Pakning	801547252
	FH12 (1-cyl.)	LK3930AT
	O-ring	269067

Volvo Lastbil

Illustration	Beskrivelse	Bestillingsnr.
	FH12 (2-cyl.)	LP4985AT
	O-ring	269067
	Pakning	801547252
	FH12 (Version 2)	412.704.008.7
	FH12 (Version 2)	412.704.014.7
	FM	LP4960AT
	O-ring	269067
	Pakning	801547252

Håndbremseventiler

Scania Lastbil

Illustration	Beskrivelse	Bestillingsnr.
	Serie 3 M14x1,5	961.722.314.7
	Serie 4	961.723.122.0

Volvo Lastbil

Illustration	Beskrivelse	Bestillingsnr.
	<p>FL7 - FL10 M14x1,5</p>	<p>961.722.324.7</p>
	<p>FH12 - FH16 M16x1,5</p>	<p>961.723.212.0</p>
	<p>FL614 - 618 M16x1,5</p>	<p>961.723.004.0</p>

4-Kreds beskyttelsesventiler

Scania Lastbil

Illustration	Beskrivelse	Bestillingsnr.
	Serie 3 (-1183836 / -4315951) M16x1,5 / M22x1,5	934.702.381.7
	Serie 3 (1183837- / 4315952-) Serie 4 M16x1,5 / M22x1,5	934.702.387.0
	Serie 4 M16x1,5 / M22x1,5	934.714.211.0

Volvo Lastbil



Illustration	Beskrivelse	Bestillingsnr.
	FH	AE4604
	F/FH	AE4428
	F/FL M16x1,5 / M22x1,5	934.702.042.7
	F/FL M16x1,5 / M22x1,5	934.702.381.7

4-Kreds beskyttelsesventiler

Volvo Lastbil

Illustration	Beskrivelse	Bestillingsnr.
	FH M16x1,5 / M22x1,5	AE4452
	FH version 2	934.714.140.0

Mercedes Lastbil

Illustration	Beskrivelse	Bestillingsnr.
	Max. 13 bar	934.705.005.0
	M22x1,5	AE4404

Daf Lastbil

Illustration	Beskrivelse	Bestillingsnr.
	M16x1,5 / M22x1,5	934.702.381.7

Relæventiler

Scania Lastbil

Illustration	Beskrivelse	Bestillingsnr.
	Serie 3	KY1810/1
	Serie 3	AC574CXY
	Serie 3 + 4 + R	973.011.000.7
	Serie 4	973.011.050.0

Volvo Lastbil

Illustration	Beskrivelse	Bestillingsnr.
	FL + FH	973.011.000.7

Mercedes/DAF Lastbil

Illustration	Beskrivelse	Bestillingsnr.
DAF/MB 	Port 1 = M22x1,5 Port 2 = M16x1,5 Port 4 = M16x1,5	973.001.020.7



MAN

Illustration	Beskrivelse	Bestillingsnr.
	TGA	973.003.007.0

Daf/Renault Lastbil

Illustration	Beskrivelse	Bestillingsnr.
	M16x1,5 / M22x1,5	973.011.000.7

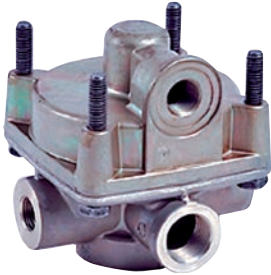
Trailer

Illustration	Beskrivelse	Bestillingsnr.
	Max. 8 bar M22x1,5	973.001.010.7
	Wabco relæventil med over- lastbeskyttelse Max. 12 bar M16x1,5	973.011.201.0

Volvo

Illustration	Beskrivelse	Bestillingsnr.
	Elektrisk 4-kantet stik	338.050.101

Wabco

Illustration	Beskrivelse	Bestillingsnr.
	Port 1 = M16x1,5 Port 21 = M12x1,5 Port 24 = M12x1,5	463.032.020.7

Hæve- sænkeventiler

Knorr

Illustration	Beskrivelse	Bestillingsnr.
 A black lift/lower valve with a black handle and a black knob. The valve has a brass body and a black top cap. The word "STOP" is visible on the side of the valve.	M16x1,5	SV3111
 A black lift/lower valve with a black handle and a black knob. The valve has a brass body and a black top cap. The word "STOP" is visible on the side of the valve.	M16x1,5	SV3115
 A brass lift/lower valve with a black handle and a black knob. The valve has a brass body and a black top cap. The word "STOP" is visible on the side of the valve.	EBS	SV3293

Haldex

Illustration	Beskrivelse	Bestillingsnr.
	M12x1,5	338.021.001
	VVI-Colas	338.051.101
	Håndtag	950.338.027
	Bla. for Kelberg	338.054.001
	Schmitz hæve/sænkeventil	055717

Anhængerstyreventiler

Scania Lastbil

Illustration	Beskrivelse	Bestillingsnr.
	Serie 4 / Serie R	973.009.010.7

Volvo/Mercedes/Man/Iveco/Renault

Illustration	Beskrivelse	Bestillingsnr.
	Wabco anhænger styreventil	973.002.521.7

Wabco

Illustration	Beskrivelse	Bestillingsnr.
	Uden foriling M22x1,5	471.005.020.7
	Uden flange for manuel betjening. M22x1,5	971.002.000.7
	Med justerbar foriling M22x1,5	971.002.150.7
	Med justerbar foriling M16x1,5 / M22x1,5	971.002.152.7

Anhængerbremseventiler

Wabco

Illustration	Beskrivelse	Bestillingsnr.
	<p>Ny type Med justerbar foriling M16x1,5 / M22x1,5</p>	971.002.300.7
	<p>Ventilen er sammensat af 971.002.150.7 + 963.001.012.7</p>	971.002.531.0
	<p>Erstatter 971.002.802.0</p> <p>Ved erstatning af 971.002.802.0 skal 971.002.805.0 + monteringsæt 971.002.921.2 eller 971.002.922.2 anvendes afhængig af hvilken årgang TEBS. 921 til C1 og C2, 922 til C3 og D.</p>	971.002.805.0

Haldex

Illustration	Beskrivelse	Bestillingsnr.
	<p>ABS - MGX</p>	950.364.104

Scania Lastbil

Illustration	Beskrivelse	Bestillingsnr.
<p>A grey metal valve with a black corrugated hose on the left side and a blue cap on top. It has several ports and a red label on the side.</p>	<p>Serie 3 - 4, 4x2 (luftaffjedring)</p>	<p>475.700.122.7</p>
<p>A grey metal valve similar to the first one, but with a blue cap and a blue handle on the right side. It has a black corrugated hose on the left.</p>	<p>Serie 3 - 4, 6x2 (luftaffjedring)</p>	<p>475.700.126.0</p>
<p>A grey metal valve with a large circular port on the left side and a smaller port on the right. It has a blue cap on top and a blue handle on the right side.</p>	<p>Serie 3 - 4 (bladaffjedring)</p>	<p>1186938</p>



Volvo Lastbil

Illustration	Beskrivelse	Bestillingsnr.
	<p>FL (bladaffjedring)</p>	<p>0 481 065 004</p>
	<p>FH</p>	<p>0 481 036 206</p>
	<p>FH forvogn</p>	<p>475.711.074.0</p>
	<p>FH trækker</p>	<p>475.711.075.7</p>

Volvo Lastbil

Illustration	Beskrivelse	Bestillingsnr.
	Luftaffjedring	475.711.009.0



Mercedes Lastbil

Illustration	Beskrivelse	Bestillingsnr.
	Luftaffjedring	475.710.020.7
	Luftaffjedring	475.702.020.7

Mercedes Lastbil

Illustration	Beskrivelse	Bestillingsnr.
	Bladaffjedring	475.702.022.7

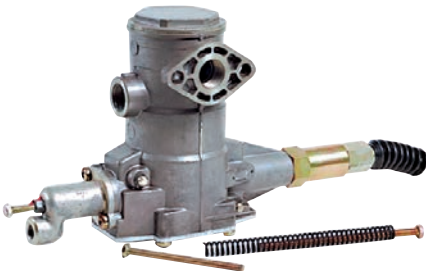
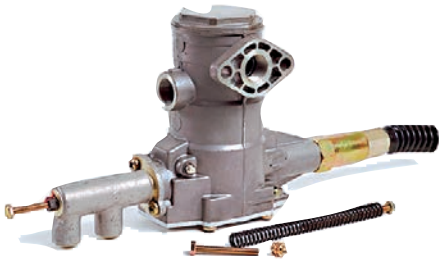
Trailer

Illustration	Beskrivelse	Bestillingsnr.
	Luftaffjedring	475.700.220.7
	Luftaffjedring	475.700.403.7
	Luftaffjedring 1x M22x1,5 2x M16x1,5 2x M12x1,5	475.714.500.7
	Alternativ (knor bremsekratfregulator)	BR5522

Trailer

Illustration	Beskrivelse	Bestillingsnr.
	Luftaffjedring 1x M22x1,5 2x M16x1,5 2x M12x1,5	475.714.509.7
	Luftaffjedring	475.715.500.7
	Luftaffjedring	602.005.001
	Bladaffjedring (30gr.)	475.701.001.7



Trailer

Illustration	Beskrivelse	Bestillingsnr.
	Bladaffjedring (15gr.)	475.701.020.7
	Bladaffjedring	475.702.020.7
	Bladaffjedring	475.702.022.7
	Bladaffjedring	475.713.500.7

Trailer

Illustration	Beskrivelse	Bestillingsnr.
	Bladaffjedring	475.800.301.7

Tilbehør

Illustration	Beskrivelse	Bestillingsnr.
	Gummiophæng for ALB-ventil m10 gevind	27120
	Stang - ALB-ventil	464.006.730.2
	ALB fjederelement	433.302.002.0
	Bolt for fjederelementet	109FZ

Tilbehør



Illustration	Beskrivelse	Bestillingsnr.
 <p>A technical specification card for WABCO ALB skilt - luftaffjedring. It includes fields for 'Vorderachse / Front axle / Essieu avant' and 'Hinterachse / Rear axle / Essieu arrière', and a table for 'Auslass / Air line / Charge (kg)', 'Ansprungdruck / Output pressure / Pression (bar)', and 'Weg & am Hebel / Stroke & at lever / Course & at wheel' for both front and rear axles.</p>	<p>ALB skilt - luftaffjedring</p>	<p>899.144.631.4</p>
 <p>A technical specification card for Wabco alb-skilt bladaffjedring. It includes fields for 'Vorderachse / Front axle / Essieu avant' and 'Hinterachse / Rear axle / Essieu arrière', and a table for 'Auslass / Air line / Charge (kg)', 'Ansprungdruck / Output pressure / Pression (bar)', and 'Weg & am Hebel / Stroke & at lever / Course & at wheel' for both front and rear axles.</p>	<p>Wabco alb-skilt bladaffjedring</p>	<p>899.144.630.4</p>
	<p>Gummitrykstykke, 6 mm hul</p>	<p>765110</p>
	<p>Gummitrykstykke, 8 mm hul</p>	<p>765120</p>
	<p>Gummitrykstykke, 6 mm hul</p>	<p>765100</p>
	<p>Gummitrykstykke, 8 mm hul</p>	<p>765130</p>

Tilbehør

Illustration	Beskrivelse	Bestillingsnr.
	Monteringsset komplet	765160

Liftakselventiler



Wabco

Illustration	Beskrivelse	Bestillingsnr.
	Manuel håndbetjent 4,0 bar	463.084.000.0
	Elektrisk	463.084.011.7
	Automatisk	463.084.021.0



Knorr

Illustration	Beskrivelse	Bestillingsnr.
	M16x1,5	AE1141

Knorr

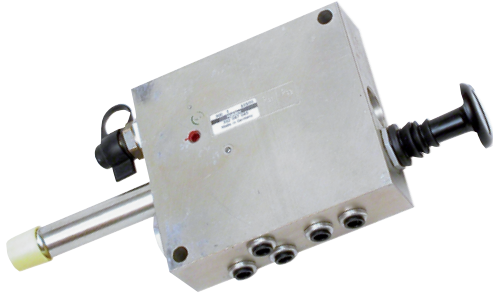

Illustration	Beskrivelse	Bestillingsnr.
	M12x1,5	AE1124
	1/8" NPTF bl.a. Fruehauf	LS2000

Haldex



Illustration	Beskrivelse	Bestillingsnr.
	Manuel 5 tilslutninger 4,5 bar	352.047.045
	Haldex IIas ventil - elektrisk	352.061.011

Hurtigudløserventiler

Wabco

Illustration	Beskrivelse	Bestillingsnr.
	Port 1 = M22x1,5 Port 2 = 2x M22x1,5 Port 3 = M22x1,5 (afluftning)	973.500.000.0
	Port 1 = M22x1,5 Port 2 = 4x M16x1,5 Port 3 = M22x1,5 (afluftning)	973.500.038.0
	Port 1 = 2x M22x1,5 Port 2 = 4x M16x1,5 Port 3 = M22x1,5 (afluftning)	973.500.051.0

Knorr

Illustration	Beskrivelse	Bestillingsnr.
	Port 1 = M22x1,5 Port 2 = 2x M16x1,5 Port 3 = M16x1,5 (afluftning)	KX1294-1
	Port 1 = M22x1,5 Port 2 = 2x M16x1,5 Port 3 = M16x1,5 (afluftning)	KX2196-1
	Port 1 = M22x1,5 Port 2 = 2x M16x1,5 Port 3 = M22x1,5 (afluftning)	KX2552-3

Løsnerventiler



Wabco

Illustration	Beskrivelse	Bestillingsnr.
	M22x1,5	463.034.000.0
	M22x1,5	463.034.005.0
	M22x1,5	963.001.000.7
	M16x1,5	963.001.012.7



Wabco

Illustration	Beskrivelse	Bestillingsnr.
	M22x1,5	963.001.013.7
	M16x1,5	963.001.016.7
	M16x1,5	963.001.051.7
	M16x1,5	963.006.001.7

Wabco

Illustration	Beskrivelse	Bestillingsnr.
	M16x1,5	963.006.003.0
	M16x1,5	963.006.005.0

Haldex

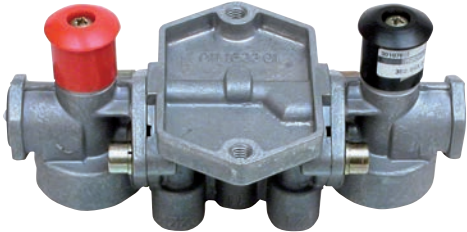
Illustration	Beskrivelse	Bestillingsnr.
	M16x1,5	352.018.011
	M16x1,5	352.019.011
	M16x1,5	352.045.001

Fodbremseventiler



Scania Lastbil

Illustration	Beskrivelse	Bestillingsnr.
	Serie 3	0 481 064 701A
	Serie 3	461.315.008.7
	Serie 3	461.315.042.7
	Serie 4	461.315.180.7



Scania Lastbil

Illustration	Beskrivelse	Bestillingsnr.
	Serie 4 (med EBS)	0 486 200 009

Volvo Lastbil

Illustration	Beskrivelse	Bestillingsnr.
	F/FH	MB4849
	F/FH	461.315.042.7

Mercedes Lastbil

Illustration	Beskrivelse	Bestillingsnr.
	Basisventil	461.315.008.7
	Basisventil	461.319.260.7

Wabco (med tilbageløb)

Illustration	Beskrivelse	Bestillingsnr.
	4,5 bar M22x1,5	434.100.022.0
	6,0 bar M22x1,5	434.100.024.0
	6,5 bar M22x1,5	434.100.025.0
	10,3 bar M22x1,5	434.100.047.0

Wabco (uden tilbageløb)

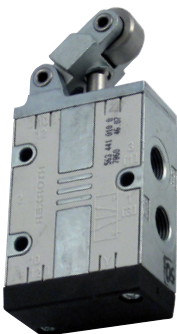

Illustration	Beskrivelse	Bestillingsnr.
	4,5 bar M22x1,5	434.100.122.0
	5,0 bar M22x1,5	434.100.123.0
	5,5 bar M22x1,5	434.100.124.7
	6,0 bar M22x1,5	434.100.125.7
	6,5 bar M22x1,5	434.100.126.0
	7,0 bar M22x1,5	434.100.130.0
	10,0 bar M22x1,5	434.100.136.0

Wabco (med begrænset tilbageløb)

Illustration	Beskrivelse	Bestillingsnr.
	4,0 bar	434.100.223.0

3/2, 4/2, 5/2-vejs ventiler

3/2-vejs ventiler

Illustration	Beskrivelse	Bestillingsnr.
	3/2-vejs	571.040.000.0
	3/2-vejs	563.441.010.0
	3/2-vejs	550.109.000.0

4/2-vejs ventiler

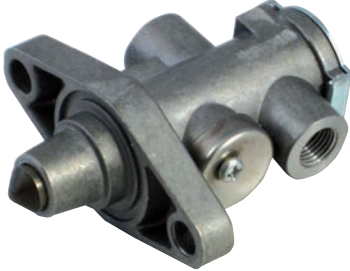

Illustration	Beskrivelse	Bestillingsnr.
	4/2-vejs Europa	563.018.010.0
	4/2-vejs hane	0 484 351 005

5/2-vejs ventiler

Illustration	Beskrivelse	Bestillingsnr.
	5/2-vejs Europa	563.131.210.0
	5/2-vejs Europa	577.705.022.0
	Sokkel til stikben	894.101.520.2

Gearskifteventiler

Scania Lastbil

Illustration	Beskrivelse	Bestillingsnr.
	Serie 4	70114520
	Serie 3 - 4	701423566

Volvo Lastbil

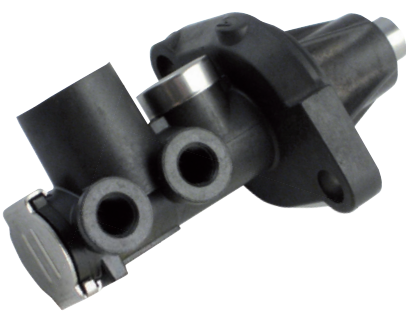
Illustration	Beskrivelse	Bestillingsnr.
	F/FH/FM	801068951
	FH/FM	80232159

Knorr



Illustration	Beskrivelse	Bestillingsnr.
	14,0 bar	KX1729-4
	10,3 bar	KX1729-2

Trykbegrænsningsventiler



Scania

Illustration	Beskrivelse	Bestillingsnr.
	4-serie luftaffjedring	475.010.200.0

Wabco



Illustration	Indstillet tryk (bar)	Ved indstyret tryk (bar)	Indstillingsområde (bar)	Bestillingsnr.
	7,0	10,0	6,9 - 9,0	475.010.000.7
	1,8	7,5	3,5 - 6,0	475.010.002.7
	8,5	10,0	5,8 - 10,8	475.010.300.7
	5,3	7,5	1,2 - 6,2	475.010.302.7

Wabco

Illustration	Indstillet tryk (bar)	Ved indstyret tryk (bar)	Indstillings-område (bar)	Bestillingsnr.
	6,0	7,5	5,8 - 10,8	475.010.305.0
	1,8	8,0	1,2 - 6,2	475.010.307.0
	8,0	9,8	...	475.010.400.0

Trykregulatorer

Trykregulatorer

Illustration	Beskrivelse	Bestillingsnr.
 A complex, multi-ported metal pressure regulator with a central adjustment screw and a pressure gauge on top.	Knorr trykregulator 8,1 bar	0 481 039 221
 A simpler, cylindrical metal pressure regulator with a side-mounted adjustment screw and a pressure gauge on top.	Knorr trykregulator 6,6 - 7,6 bar	1189393



Scania Lastbil

Illustration	Beskrivelse	Bestillingsnr.
 A black rectangular WABCO ECAS control box with a coiled black cable and a red 5-pin connector. The box has several buttons and the WABCO logo.	ECAS 5-polet stik	446.056.146.0

Man Lastbil

Illustration	Beskrivelse	Bestillingsnr.
 A black rectangular WABCO ECAS control box with a coiled black cable and a 9-pin connector. The box has several buttons labeled M1, M2, stop, and others, and the WABCO logo.	ECAS 9-polet stik	446.056.117.0

Trailere

Illustration	Beskrivelse	Bestillingsnr.
	Wabco VCS elektronik	400.602.493.0
	Kabel f. sættevogn	449.534.043.0
	Kabel f. anhænger	449.544.333.0
	Haldex elektronik Modal	950.364.081

Scania / Mercedes Lastbil

Illustration	Beskrivelse	Bestillingsnr.
	Serie 3 - 4 (24x1) / Mercedes	BR9152
	Serie 4 - R	472.195.018.0

Volvo Lastbil

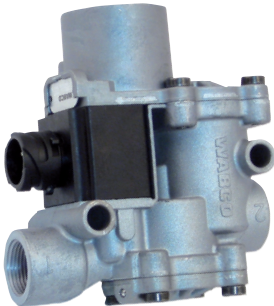
Illustration	Beskrivelse	Bestillingsnr.
	Bajonetfatning M22x1,5	472.195.018.0
	Adapterkabel	5208456X

Mercedes/DAF

Illustration	Beskrivelse	Bestillingsnr.
	Bajonetfatning M22x1,5	472.195.016.0



Man Lastbil

Illustration	Beskrivelse	Bestillingsnr.
	Bajonettfatning M22x1,5	472.195.009.0

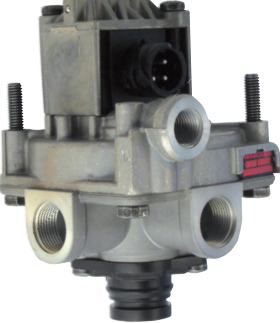
Trailer

Illustration	Beskrivelse	Bestillingsnr.
	ABS anlæg komplet vcs II System: 4s/3m..2s/2m Standard indstilling 2s72m	400.500.082.0
	Løs relæventil	472.195.031.7
	Vario C	472.195.031.7
	Adapterkabel	894.601.132.2

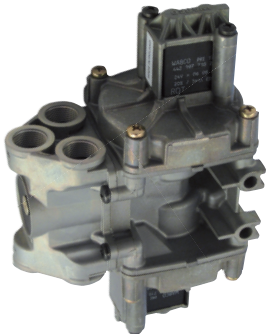
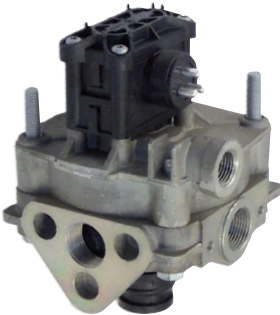

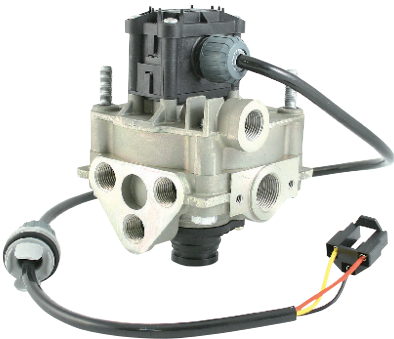

Trailer

Illustration	Beskrivelse	Bestillingsnr.
	Vario C	472.195.041.7
	Adapterkabel	894.601.132.2
	Modal 2-ports	950.364.048
	Modal 6-ports	950.364.047

Trailer

Illustration	Beskrivelse	Bestillingsnr.
 A cast metal ABS valve with a black electrical cable and a red terminal.	MGX-2E/MGX-100	950.364.104
 A cast metal ABS valve with a black electrical cable and a multi-pin connector.	Modal 6-ports	950.364.045

Sensorer og sensorsæt

Illustration	Beskrivelse	Bestillingsnr.
	Sensorsæt - Wabco	441.032.921.2
	Løs sensor- Knorr	0 486 000 126
	Sensorsæt (lige) 350 mm - Wabco	441.032.963.2
	Sensorsæt 1000 mm - Wabco	441.032.922.2
	Sensorbøsning	899.760.510.4

Sensorer og sensorsæt

Illustration	Beskrivelse	Bestillingsnr.
	Sensorbøsning	899.759.815.4

ABS Sensorforlængerkabler - VCS

Illustration	Beskrivelse	Bestillingsnr.
	1.780 mm	449.712.018.0
	2.300 mm	449.712.023.0
	3.000 mm	449.712.030.0
	3.810 mm	449.712.038.0
	5.080 mm	449.712.051.0
	6.000 mm	449.712.060.0
	8.000 mm	449.712.080.0
	10.000 mm	449.712.100.0



ABS Sensorforlængerkabler

Illustration	Beskrivelse	Bestillingsnr.
	5.000 mm	449.715.050.0
	8.000 mm	449.715.080.0

EBS Tryksensorkabler

Illustration	Beskrivelse	Bestillingsnr.
	3.000 mm	449.752.030.0

Adapterkabel

Illustration	Beskrivelse	Bestillingsnr.
	Længde 400mm	449.444.022.0
	Adapterkabel, bajonet - indvendig m24x1	894.601.133.2
	Adapterkabel, bajonet - udvendig m27x1	894.601.134.2

Adapterkabel

Illustration	Beskrivelse	Bestillingsnr.
	Adapterkabel, bajonet - indvendig m27x1	894.601.135.2

Scania Lastbil

Illustration	Beskrivelse	Bestillingsnr.
	Serie 4	0 486 203 026

Volvo Lastbil

Illustration	Beskrivelse	Bestillingsnr.
	FH version 2	0 486 204 025
	EBS modulatorventil FH version II	8020828239
	FH/FM	0 486 203 024

Mercedes / Man / Daf / Iveco Lastbil

Illustration	Beskrivelse	Bestillingsnr.
	EBS anhængerstyreventil	480.204.002.0

Trailer

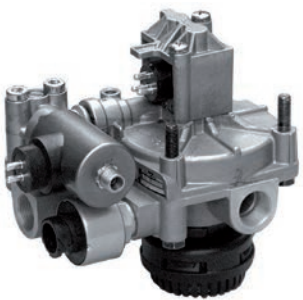
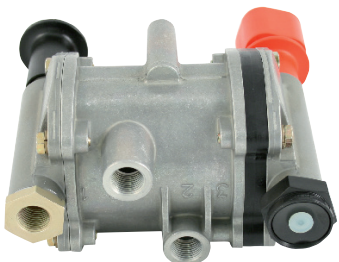
Illustration	Beskrivelse	Bestillingsnr.
	EBS anhængerbremseventil	971.002.805.0
	EBS relæventil	480.207.001.0
	EBS dobbelt løsnerventil	AE4311

Trailer

Illustration	Beskrivelse	Bestillingsnr.
	EBS modulator	ES2050
	EBS modulator	ES2053
	EBS anhængerstyreventil	480.204.002.0
	EBS sikkerhedsventil	971.002.900.0

Trailer

Illustration	Beskrivelse	Bestillingsnr.
	EBS d/rss modulator	480.102.014.0
	Haldex modulator EBS EB+ ADR version	950 800 302
	Haldex EBS kontakt (Fruehauf/SMB)	950.800.903

EBS tilbehør

Illustration	Beskrivelse	Bestillingsnr.
	Wabco ebs-skilt selvklæbende	899.200.922.4



Scania Lastbil

Illustration	Beskrivelse	Bestillingsnr.
	Serie 3 (med lastoverførsel)	472.900.012.0
	Serie 3 (uden lastoverførsel)	472.900.013.7
	(Løs magnet)	472.900.923.2
	Serie 4	472.900.112.0

Scania Lastbil

Illustration	Beskrivelse	Bestillingsnr.
	Serie R	472.905.111.0

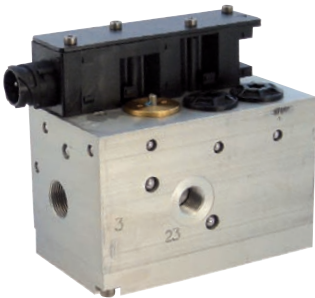
Volvo Lastbil

Illustration	Beskrivelse	Bestillingsnr.
	FH	0 501 100 029
	FH Venstre	0 501 100 052
	FH Højre	0 501 100 055

Mercedes Lastbil

Illustration	Beskrivelse	Bestillingsnr.
	Sensor for Actros	441.050.012.0

Man Lastbil

Illustration	Beskrivelse	Bestillingsnr.
	Sensor for F2000 / M2000	441.050.011.0

Daf Lastbil

Illustration	Beskrivelse	Bestillingsnr.
	Sensor for Daf 75,85,95XF	441.050.100.0

Tryksensorer

Illustration	Beskrivelse	Bestillingsnr.
	<p>Max. 10 bar Bajonetfatning M16x1,5</p>	<p>441.044.102.0</p>
	<p>Max. 16 bar Bajonetfatning M16x1,5</p>	<p>441.044.001.0</p>

Volvo

Illustration	Beskrivelse	Bestillingsnr.
	FH	0 481 009 047

Wabco - Tilpasningsventiler

Illustration	Beskrivelse	Bestillingsnr.
	0,7 bar	975.001.000.7

Wabco - Knæk-kurve-ventiler

Illustration	Beskrivelse	Bestillingsnr.
	10 bar M22x1,5	975.002.005.0

Kontraventiler

Wabco

Illustration	Beskrivelse	Bestillingsnr.
 A straight, cylindrical metal valve with hexagonal ends. The left end has a threaded female connection, and the right end has a hexagonal nut. A small label on the side reads "WABCO" and "434.014.000.0".	M22x1,5	434.014.000.0
 A T-junction metal valve with three threaded ports. One port is on the left, one on the right, and one pointing downwards. A label on top reads "MADE IN POLAND" and "WABCO".	M22x1,5	434.208.029.0

Knorr

Illustration	Beskrivelse	Bestillingsnr.
 A metal valve with a mounting bracket. It has a threaded port on the left and a smaller port on top. A label on the side reads "KNORR".	M16x1,5	295358

Wabco

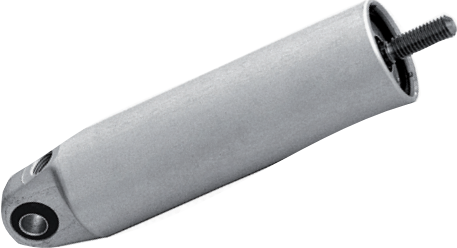
Illustration	Beskrivelse	Bestillingsnr.
	Stempel Ø32 - Slaglængde 52 mm	421.445.000.0
	Stempel Ø35 - Slaglængde 60 mm	421.411.314.0
	Stempel Ø28 - Slaglængde 48 mm	SZ1161

Spærre-ventiler/cylindre

Spærreventiler/ - cylindre

Illustration	Beskrivelse	Bestillingsnr.
	Wabco spærrecylinder ø65 / 2 bar	425.311.004.7
	Wabco spærreventil	964.001.002.7
	Wabco låsecylinder - type 24	925.407.003.0
	Haldex cylinder - ø30x35	341.032.011

Scania Lastbil

Illustration	Beskrivelse	Bestillingsnr.
	Serie 3	701118884
	Serie 4	70318686
	Serie 4 / Serie R	464.007.010.0
	Serie R, P og 4 -for og bag på førerhus	70122394

Volvo Lastbil

Illustration	Beskrivelse	Bestillingsnr.
	FH Max. 10 bar M10x1	464.007.002.0

Mercedes Actros

Illustration	Beskrivelse	Bestillingsnr.
	Wabco	464.007.011.0

Man/Daf/Iveco/Renault Lastbil

Illustration	Beskrivelse	Bestillingsnr.
	Max. 10 bar	464.007.001.0



Scania Lastbil

Illustration	Beskrivelse	Bestillingsnr.
	Serie 3 - 4	612.031.011

Volvo Lastbil

Illustration	Beskrivelse	Bestillingsnr.
	F/FH 2 port/2 trin	464.006.000.7
	FH/FM Elektronisk	0 504 002 112

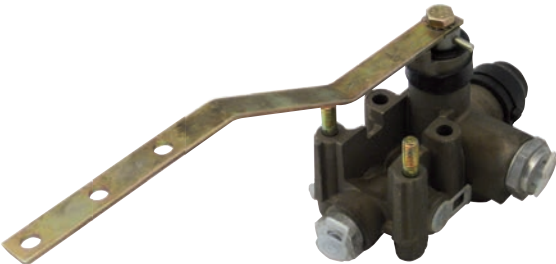
Mercedes / Man Lastbil

Illustration	Beskrivelse	Bestillingsnr.
	Vestre - Man	SV1369
	Højre - Man	SV1370

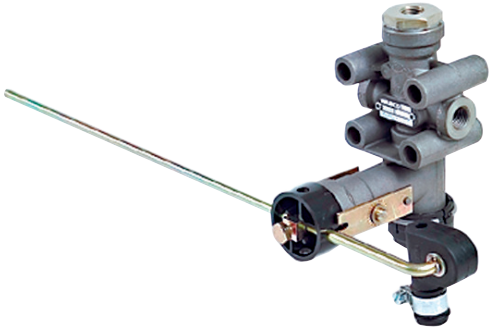

Mercedes / Man / Daf / Iveco / Renault Lastbil

Illustration	Beskrivelse	Bestillingsnr.
	2 port/2 trin M12x1,5	464.006.002.7

Bus

Illustration	Beskrivelse	Bestillingsnr.
	M12x1,5	SV1294

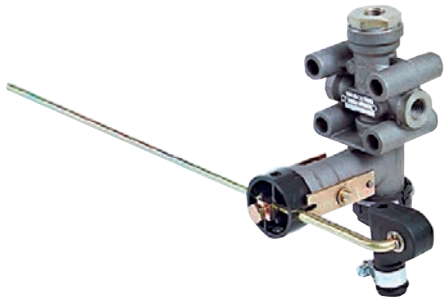
Trailer

Illustration	Beskrivelse	Bestillingsnr.
	Uden højdestop (=SV1395)	464.006.002.7
	Med højdestop	464.006.101.0

Trailer

Illustration	Beskrivelse	Bestillingsnr.
	Med højdestop	464.006.100.7
	Med højdestop	612.032.001
	Med højdestop	SV1466
	Med højdestop	SV1465

Trailer

Illustration	Beskrivelse	Bestillingsnr.
	<p>Uden højdestop (=464.006.002.7)</p>	<p>SV1395</p>
	<p>Til 2 kørehøjder</p>	<p>SV1295</p>

Proportionalventiler

Scania

Illustration	Beskrivelse	Bestillingsnr.
 A small, cylindrical metal valve with a black top cap and several ports. It has a black circular component on the side with two electrical terminals.	Wabco proportionalventil - Scania hast.begrænser	472.250.000.0



Volvo

Illustration	Beskrivelse	Bestillingsnr.
 A larger, rectangular metal valve with a complex internal structure visible through a central opening. It has several ports and a black component on the left side.	FH/FM (motorbremse)	80214263

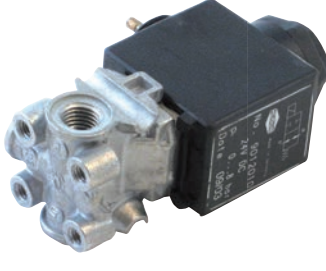
Scania Lastbil

Illustration	Beskrivelse	Bestillingsnr.
	Normalt lukket (åben ved strøm)	709041010
	Normalt åben (lukket ved strøm)	709012010

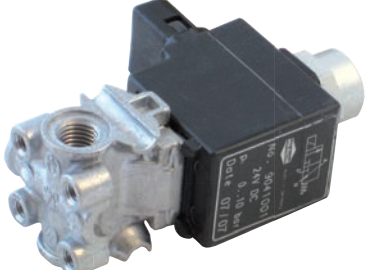
Volvo Lastbil

Illustration	Beskrivelse	Bestillingsnr.
	Normalt lukket (åben ved strøm)	809041001
	Normalt åben (lukket ved strøm)	809041005

Iveco Lastbil

Illustration	Beskrivelse	Bestillingsnr.
	Normalt lukket (åben ved strøm)	472.172.626.0
	Normalt åben (lukket ved strøm)	472.172.726.0



Trailer

Illustration	Beskrivelse	Bestillingsnr.
	Normalt åben (lukket ved strøm)	472.090.052.0
	Normalt lukket (åben ved strøm)	472.090.202.0
	Normalt åben (lukket ved strøm)	472.171.726.0
	Kabel f. magnetventil	449.515.020.0

Trailer

Illustration	Beskrivelse	Bestillingsnr.
	Normalt lukket (åben ved strøm)	472.172.626.0
	Kabel f. magnetventil	449.515.020.0
	Normalt lukket (åben ved strøm)	472.172.600.0
	24V Arbejdstryk 8,5 bar M12x1,5 gevind	472.127.140.7

Tilbehør

Illustration	Beskrivelse	Bestillingsnr.
	Wabco kabel med stik for magnetventil, 7 m kabel	449.515.070.0
	Wabco kabel med stik for magnetventil, 2 m kabel	449.515.020.0

Stempelcylindre

Wabco

Illustration	Beskrivelse	Bestillingsnr.
 A black, cylindrical piston cylinder with a ribbed piston rod and a mounting bracket. The piston rod has a yellow tip.	Stempel \varnothing 140 - Slaglængde 160 mm	421.005.020.0
 A black, cylindrical piston cylinder with a ribbed piston rod and a mounting bracket. The piston rod has a black tip.	Stempel \varnothing 127 - Slaglængde 140 mm	921.004.000.0
 A black, cylindrical piston cylinder with a ribbed piston rod and a mounting bracket. The piston rod has a black tip.	Stempel \varnothing 152 - Slaglængde 175 mm	921.006.000.0

Afspærrehaner

Illustration	Beskrivelse	Bestillingsnr.
	22 mm	769240
	22 mm - Wabco	452.002.132.0
	22 mm - Haldex	334.077.001

Membrancylindre

Membrancylindre - normal hub

Illustration	Beskrivelse	Bestillingsnr.
	16"	1186699-01
	20"	1186700-01
	24"	1186701-01
	30"	1186702-01
	16"	295531
	20"	295532
	24"	295533
	30"	295534
	36"	295535

Membrancylindre - Speciel

Illustration	Beskrivelse	Bestillingsnr.
	36" med rulle, til hævbar aksel	05.444.10.37.0
	3" til containerhejs (låser containeren)	423.020.000.0

Membrancyindre - lang hub



Illustration	Beskrivelse	Bestillingsnr.
	9"	423.102.900.0
	12"	76.399.0
	16"	76.400.0
	20"	76.401.0
	24"	76.402.0
	30"	76.403.0
	36"	76.404.0

Membrancyindre - skivebremser

Illustration	Beskrivelse	Bestillingsnr.
	14"	423.114.710.0
	16"	423.104.710.0
	18"	423.112.710.0
	20"	423.505.000.0
	24"	423.506.001.0
	27"	423.109.710.0

Fjederbremsecylindre

Fjederbremsecylindre - Tristop

Illustration	Beskrivelse	Bestillingsnr.
	16/24	925.494.041.7
	20/24 (Wabco) 20/24 (Alternativ)	925.430.100.7 925430100A
	24/24 24/24 (Alternativ)	925.491.114.7 925431100A
	30/24 30/24 (Alternativ)	925.492.204.0 925432300A
	30/30 30/30 (Alternativ)	925.492.102.7 925452001A
	24/30	925.431.490.7

Fjederbremsecylindre - Bendix

Illustration	Beskrivelse	Bestillingsnr.
	16/80	K2B0502XU
	20/80	K2B0504SX
	24/80	K2B0506SX
	24/105	4128549
	30/98	K2B0521SX
	30/105	K2B0522XU

Fjederbremsecylindre - Scania

Illustration	Beskrivelse	Bestillingsnr.
	20/24 3-4 serie	70118882

Fjederdel - Bendix

Illustration	Beskrivelse	Bestillingsnr.
	16/80	K2B0002XU
	20/80	K2B0004SX
	24/80	K2B0006SX
	24/105	K2B0014SX
	30/98	K2B0021SX
	30/105	K2B0022XU

Fjederbremsecylinder - Anchorlock

Illustration	Beskrivelse	Bestillingsnr.
	20/24	BX7401
	24/24	BX7516
	24/30 (lav model)	BX7514
	Knor 24/30 (høj model) Alt.	BX7523 925371300A
	Knor 30/30 Alt.	BX7611 925372300A

Fjederbremsecylinder - Skivebremser

Illustration	Beskrivelse	Bestillingsnr.
	16/16 - venstre	925.464.451.0
	16/16 - højre	925.464.450.0
	16/24 - venstre	925.464.500.0
	16/24 - højre	925.464.501.0
	18/24 - venstre	925.463.501.0
	18/24 - højre	925.463.500.0
	20/24 - venstre	925.460.100.0
	20/24 - højre	925.460.101.0
	16/24 (Anchorlock) Bla. SAF ophæng	BS7309
	18/16	BS9349
	20/24	BS9404
	20/24 hfl1	BS9433
	22/24	BS9451
	24/14	BS9510
	24/24	BS9503
	24/30	BS8500

Tilbehør fjederbremse- og membrancyindre

Gummimembraner - højde 35 mm

Illustration	Beskrivelse	Bestillingsnr.
	9" (udv. 127 mm)	764171
	12" (udv. 144 mm)	764121
	16" (udv. 160 mm)	764051
	20" (udv. 174 mm)	764061
	24" (udv. 185 mm)	764071
	30" (udv. 209 mm)	764081
	36" (udv. 230 mm)	764091

Gummimembraner - højde 50 mm

Illustration	Beskrivelse	Bestillingsnr.
	12" (udv. 138 mm)	B74479
	16" (udv. 160 mm)	764131
	20" (udv. 174 mm)	764141
	24" (udv. 185 mm)	764151
	30" (udv. 209 mm)	764161

Trykfjedre

Illustration	Beskrivelse	Bestillingsnr.
	Trykfjeder for membrancyindre	1188059

Gaffelstykker

Illustration	Beskrivelse	Bestillingsnr.
	M16 - Ø14 (kort model)	423.000.534.2
	M16 - Ø14 (lang model)	423.000.535.2
	M16 - Ø16	267086
	M16 - Ø1/2"	8292016

Gaffelstykker

Illustration	Beskrivelse	Bestillingsnr.
	M14 - Ø14	295518
	Z-Cam	80294020

Splitbolte

Illustration	Beskrivelse	Bestillingsnr.
	14 x 35 mm	140035
	14 x 40 mm	140040
	14 x 45 mm	140045
	16 x 42 mm	239160
	1/2" x 46 mm	127040

Trykluftbeholdere

Trykluftbeholdere - Scania

Illustration	Indhold (ltr.)	Beskrivelse	Bestillingsnr.
	16 L	Serie 3	70118391
	27 L	Serie 3 & 4	70118390

Spændebånd

Illustration	Beskrivelse	Bestillingsnr.
	Spændebånd (for 70118390/70118391)	70112675

Trykluftbeholdere - Arbejdstryk max. 10 bar

Illustration	Indhold (ltr.)	Diameter (mm)	Længde (mm)	Bestillingsnr.
	4,5	206	185	004.206.0185.10
	10,0	206	355	764501
	15,0	206	520	015.206.0520.10
	20,0	206	660	764500
	20,0	246	500	764502
	30,0	246	700	764510
	30,0	276	570	030.276.0580.10
	40,0	246	915	040.246.0915.10
	40,0	276	745	764530
	60,0	276	1100	764540
	60,0	310	880	764550
	60,0	396	565	060.396.0565.10
	80,0	396	730	764570
100,0	396	900	764580	

Beholderophæng

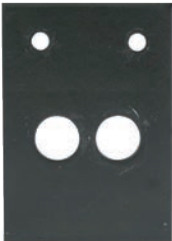

Illustration	Beholder diameter (mm)	Beholderstørrelse (ltr.)	Bestillingsnr.
	206	4,5/10/15/20	765000
	246	30	765010
	276	40	765020
	310	60	765030
	396	80/100	765040

Duomatic luftkoblinger

Duomatic Luftkoblinger

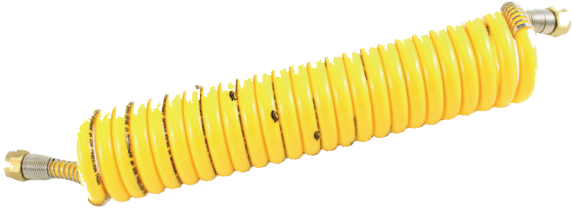

Illustration	Beskrivelse	Bestillingsnr.
	Trailer - uden ventiler	452.803.004.0
	Forvogn - med ventiler	452.802.007.0
	Anhænger - uden ventiler	452.804.012.0
	Forvogn - med ventiler	452.805.004.0

Tilbehør Duomatic

Illustration	Beskrivelse	Bestillingsnr.
	<p>Monteringsplade Duomatic</p>	<p>452.802.100.4</p>
	<p>Rep. sæt Duomatic</p>	<p>452.802.003.2</p>

Trykluft-spiralslanger



**Arb. Længde 4500 mm - indv. Ø 55 - Små vindinger "Super soft"
Med indvendig forstærkning.**

Illustration	Beskrivelse	Bestillingsnr.
	16 mm - gul	52994-M16
	22 mm - gul	52994-M22
	16 mm - rød	52995-M16
	22 mm - rød	52995-M22

**Arb. Længde 4500 mm - indv. Ø 55 - Små vindinger "Super soft"
Med indvendig forstærkning.**

Illustration	Beskrivelse	Bestillingsnr.
	16 mm - rød/gul - dobbelt	52998-M16



Arb. Længde 5500 mm - indiv. Ø 90

Illustration	Beskrivelse	Bestillingsnr.
	18 mm - sort/rød	5500
	18 mm - sort/gul	5510
	18 mm - sort/sort	5520

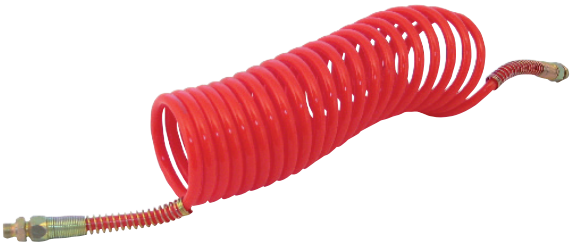
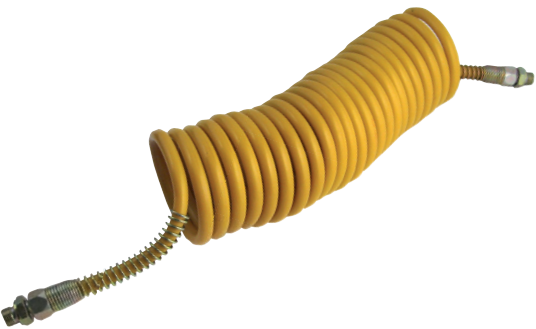

Arb. Længde 6000 mm - indv. Ø 90

Illustration	Beskrivelse	Bestillingsnr.
	16 mm - rød	5245
	22 mm - rød	5200
	16 mm - gul	5255
	22 mm - gul	5220

Arb. Længde 7500 mm - indv. Ø 90

Illustration	Beskrivelse	Bestillingsnr.
	22 mm - sort/rød	5210
	22 mm - sort/gul	5230

Arb. Længde 9500 mm - indiv. Ø 120

Illustration	Beskrivelse	Bestillingsnr.
	22 mm - rød	5215
	22 mm - gul	5235

Arb. Længde 6000 mm - Specielt for Scania

Illustration	Beskrivelse	Bestillingsnr.
	Gevind M16x1,5 - M18x1,5 - 34 mm sort	5295

Specielt for Sættevognsskamler

Illustration	Beskrivelse	Bestillingsnr.
	Spiralslange 6/4 sort Diameter: Ø36 mm Længde: 80/320 mm	9994028
	Spiralslange 8/6 sort Diameter: Ø70 mm Længde: 250/475 mm	9994034

Endefittings for Spiralslanger





Illustration	Beskrivelse	Bestillingsnr.
	M18x1,5 / M16x1,5	028 555 016
	M18x1,5 / M22x1,5	028 555 022
	M18x1,5-M18-34	028 555 118
	M16x1,5-M18-34	028 555 116

Håndtag for spiralslanger

Illustration	Beskrivelse	Bestillingsnr.
	Sæt M16x1,5	G5550000

Luftkoblinger

Luftkoblinger

Illustration	Beskrivelse	Bestillingsnr.
	16 mm - gul	769110
	22 mm - gul	769100
	16 mm - rød	769130
	22 mm - rød	769120
	16 mm - gul - automatisk	769210
	22 mm - gul - automatisk	769190
	16 mm - rød - automatisk	769220
	22 mm - rød - automatisk	769200

Luftkoblinger uden Dæksel

Illustration	Beskrivelse	Bestillingsnr.
	16 mm - uden dæksel	769290
	22 mm - uden dæksel	769160

Luftkoblinger - Knorr

Illustration	Beskrivelse	Bestillingsnr.
	24 mm udv. / 16 mm indv. - rød - m/filter	KU1400
	Alternativ	52231400
	24 mm udv. / 16 mm indv. - gul - m/filter	KU1410
	Alternativ	52231410

Lynkoblinger

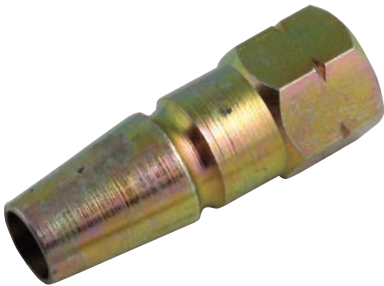
Illustration	Beskrivelse	Bestillingsnr.
	22 mm - hun	200017022
	1/2" - hun	200017001
	22 mm - han	200015022
	1/2" - han	200015001

Tilbehør Luftkoblinger

Illustration	Beskrivelse	Bestillingsnr.
	Blindkobling	769101
	Gummipakning til koblingshoved	769280

Fittings - Lige indskrning

Illustration	T	A	Bestillingsnr.
	6 x 1	M10x1	0101011
		M12x1.25	0101012
		M12x1.5	0101013
		M14x1.5	0101014
		M16x1.5	0101015
		M22x1.5	0101016
		G 1/8"	0101017
		G 1/4"	0101018
		G 3/8"	0101019
	8 x 1	M10x1	0101021
		M12x1.25	0101022
		M12x1.5	0101023
		M14x1.5	0101024
M16x1.5		0101025	
M22x1.5		0101026	
9 x 1.5	G 1/8"	0101027	
	G 1/4"	0101028	
	M12x1.5	0101113	
10 x 1	M16x1.5	0101115	
	M22x1.5	0101116	
	M12x1.5	0101103	
	M14x1.5	0101104	
	M16x1.5	0101105	
	M22x1.5	0101106	

Fittings - Lige indskrunding

Illustration	T	A	Bestillingsnr.
	10 x 1.5	M12x1.5 M16x1.5 M22x1.5	0101033 0101035 0101036
	11 x 1.5	M12x1.5 M16x1.5 M22x1.5 G 1/4"	0101123 0101125 0101126 0101128
	12 x 1.5	M12x1.5 M14x1.5 M16x1.5 M22x1.5 G1/4"	0101043 0101044 0101045 0101046 0101048
	12 x 2	M14x1.5 M16x1.5 M22x1.5 G1/4"	0101094 0101095 0101096 0101098
	15 x 1.5	M16x1.5 M22x1.5	0101055 0101056
	16 x 2	M16x1.5 M22x1.5	0101065 0101066
	18 x 2	M22x1.5	0101076
	20 x 2	M22x1.5	0101086

Fittings - Lige påskrunding

Illustration	A	Bestillingsnr.
	Ø6 - M12x1,5	0611215
	Ø8 - M14x1,5	0811415
	Ø10 - M16x1,5	1011615
	Ø12 - M18x1,5	12151815
	Ø15 - M22x1,5	15152215

Fittings - Lige samler

Illustration	T	Bestillingsnr.
	4 x 1	766580
	6 x 1	0101201
	8 x 1	0101202
	9 x 1.5	0101302
	10 x 1	0101301
	10 x 1.5	0101203
	11 x 1.5	0101303
	12 x 1.5	0101204
	12 x 2	0101209
	15 x 1.5	0101205
	16 x 2	0101206

Fittings - Vinkelstykke

Illustration	T	Bestillingsnr.
	6 x 1	0102201
	8 x 1	0102202
	12 x 1.5	0102204

Fittings - T-stykker

Illustration	T	Bestillingsnr.
	6 x 1	0103201
	8 x 1	0103202
	10 x 1	0103301
	12 x 1.5	0103204
	12 x 2	0103209

Fittings - Vinkelstykke - stilbar

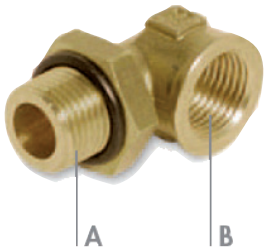
Illustration	A	B	Bestillingsnr.
	M12x1.5	M12x1.5	0102271
	M16x1.5	M12x1.5	0102272
	M16x1.5	M16x1.5	0102273
	M22x1.5	M16x1.5	0102274
	M22x1.5	M22x1.5	0102275

Fittings - Vinkelstykke

Illustration	A	Bestillingsnr.
	M12x1.5	0109241
	M16x1.5	0109242
	M22x1.5	0109243

Fittings - T-stykke - stilbar

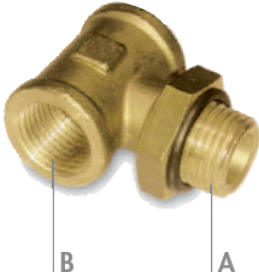
Illustration	A	B	Bestillingsnr.
	M12x1.5	M12x1.5	0103271
	M16x1.5	M16x1.5	0103272
	M22x1.5	M16x1.5	0103273
	M22x1.5	M22x1.5	0103274

Fittings - T-stykke - stilbar

Illustration	A	B	Bestillingsnr.
	M12x1.5	M12x1.5	0103281
	M16x1.5	M16x1.5	0103282
	M22x1.5	M16x1.5	0103283

Fittings - T-stykke - stilbar

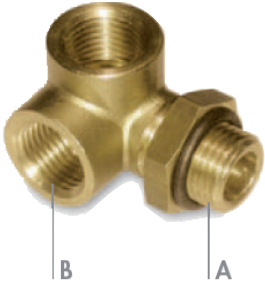
Illustration	A	B	Bestillingsnr.
	M16x1.5	M16x1.5	0103292

Fittings - T-stykke

Illustration	A	Bestillingsnr.
	M12x1.5	0109341
	M16x1.5	0109342
	M22x1.5	0109343

Fittings - Kryds - stilbar

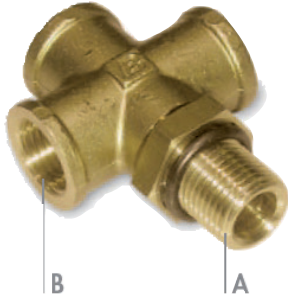
Illustration	A	B	Bestillingsnr.
	M12x1.5	M12x1.5	0104271
	M22x1.5	M16x1.5	0104273

Fittings - Overgangsstykke

Illustration	A	B	C	Bestil- lingsnr.
	M16x1.5	M22x1.5	M16x1.5	0101321
	M22x1.5	M22x1.5	M16x1.5	0101322
	M16x1.5	M22x1.5	M16x1.5	0101323*

* L = 56

Fittings - Samlestykke - stilbar

Illustration	A	B	Bestillingsnr.
 <p>* L= 44</p>	M16x1.5	M16x1.5	0101402
	M22x1.5	M22x1.5	0101403
	M22x1.5	M22x1.5	0101406*
	M16x1.5	M22x1.5	0101407

Fittings - Reduktionsstykke

Illustration	A	B	Bestillingsnr.
	M22x1.5	M16x1.5	0109631

Fittings - Blændprop

Illustration	A	Bestillingsnr.
	M12x1.5	0101251
	M14x1.5	761760
	M16x1.5	0101252
	M22x1.5	0101253

Fittings - Kontra møtrik

Illustration	A	Bestillingsnr.
<p data-bbox="478 448 502 481">A</p> 	M12x1.5	0101261
	M16x1.5	0101262
	M22x1.5	0101263

Fittings - Plug-in

Illustration	A	Bestillingsnr.
 <p><i>D=Ø15</i></p>	M10x1	0101271
	M12x1.25	0101272
	M12x1.5	0101273
	M14x1.5	0101274
	M16x1.5	0101275
	M22x1.5	0101276
	G1/8"	0101277
	G1/4"	0101278
	G3/8"	0101279

Fittings - Overgangsstykke - plug-in

Illustration	A	B	Bestillingsnr.
 <p><i>D=Ø15</i></p>	M22x1.5	M16 x 1.5	0101331

Fittings - Vinkelstykke - plug-in

Illustration	T	Ø D	Bestillingsnr.
	6 x 1	15	0102221
	8 x 1	15	0102222
	10 x 1	15	0102321
	10 x 1.5	15	0102223
	12 x 1.5	15	0102224
	12 x 2	15	0102229
	15 x 1.5	15	0102225
	16 x 2	15	0102226

Fittings - T-stykke - plug-in

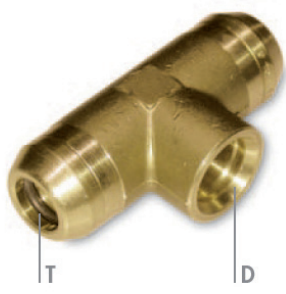
Illustration	T	Ø D	Bestillingsnr.
	6 x 1	15	0103231
	8 x 1	15	0103232
	12 x 1.5	15	0103234

Fittings - T-stykke - plug-in

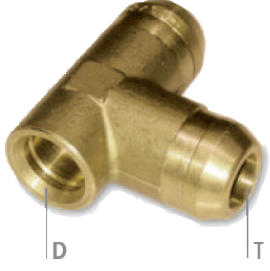
Illustration	T	Ø D	Bestillingsnr.
	8 x 1	15	0103242
	10 x 1.5	15	0103243
	12 x 1.5	15	0103244

Fittings - Vinkelstykke - plug-in

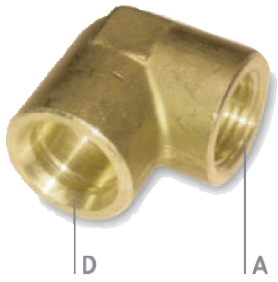
Illustration	A	Ø D	Bestillingsnr.
	M12x1.5	15	0109261
	M16x1.5	15	0109262
	M22x1.5	15	0109263

Fittings - T-stykke - plug-in

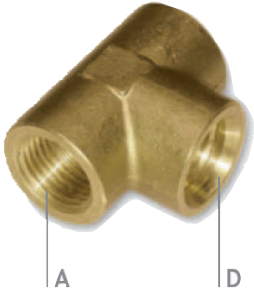
Illustration	A	Ø D	Bestillingsnr.
	M16x1.5	15	0109552

Fittings - T-stykke - plug-in

Illustration	A	Ø D	Bestillingsnr.
	M12x1.5	15	0109561
	M16x1.5	15	0109562
	M22x1.5	15	0109563

Fittings - Sortiment 2
- incl. boltreol til opbevaring

Fortsættes næste side

Illustration	Beskrivelse	Antal	Dimension
	Lige indskruning	8	6×1 M12×1,5
		8	6×1 M16×1,5
		8	6×1 M22×1,5
		8	8×1 M12×1,5
		8	8×1 M16×1,5
		8	8×1 M22×1,5
		8	10×1 M16×1,5
		8	10×1 M22×1,5
		8	12×1,5 M16×1,5
		5	12×1,5 M22×1,5
		5	15×1,5 M16×1,5
		5	15×1,5 M22×1,5
	Beskrivelse	Antal	Dimension
	Lige samler	8	6×1
		8	8×1
		8	10×1
		8	12×1,5
		5	15×1,5
	Beskrivelse	Antal	Dimension
	Blind prop	5	M12×1,5
		5	M16×1,5
		5	M22×1,5
	Beskrivelse	Antal	Dimension
T-forskruning	5	M12×1,5	
	5	M16×1,5	
	2	M22×1,5	
	Beskrivelse	Antal	Dimension
	Vinkelforskruning	5	M12×1,5
		5	M16×1,5
	3	M22×1,5	
	Beskrivelse	Antal	Dimension
	Kryds indskruning	3	M16×1,5
	3	M22×1,5 M16×1,5	

Fittings - Sortiment 2

- incl. boltreol til opbevaring

Illustration	Beskrivelse	Antal	Dimension
	Møtrik med o-ring	5	M12×1,5
		5	M16×1,5
		5	M22×1,5
	Beskrivelse	Antal	Dimension
	Vinkel indskruring	5	M12×1,5 M12×1,5
		5	M16×1,5 M16×1,5
		5	M22×1,5 M16×1,5
		5	M22×1,5 M22×1,5
	Beskrivelse	Antal	Dimension
	Lige indskruring	3	M12×1,5
		3	M16×1,5
		3	M22×1,5 M16×1,5
	Beskrivelse	Antal	Dimension
	Trevejs T-indskruring	3	M16×1,5
	Beskrivelse	Antal	Dimension
T-forskruring	5	M12×1,5	
	5	M16×1,5	
	3	M22×1,5	
Beskrivelse	Antal	Dimension	
Skot forskruring	5	M16×1,5 M22×1,5 M16×1,5	
	3	M22×1,5 M22×1,5 M16×1,5	
Beskrivelse	Antal	Dimension	
Reduktion	3	M22×1,5 M16×1,5	
Bestillingsnr.: Bertocco-sort2			

Konventionelle fittings

Lige samlere

Illustration	Dimension	Bestillingsnr.
	Ø6 - Ø6	36.010.01
	Ø8 - Ø6	37.010.01
	Ø8 - Ø8	36.011.01
	Ø10 - Ø6	37.011.01
	Ø10 - Ø8	37.012.01
	Ø10 - Ø10	36.012.01
	Ø12 - Ø8	37.014.01
	Ø12 - Ø10	37.015.01
	Ø12 - Ø12	36.013.01
	Ø15 - Ø10	37.018.01
	Ø15 - Ø12	37.019.01
	Ø15 - Ø15 (med trykring)	211.102.01
	Ø15 - Ø15 (med skærring)	36.014.01
	Ø16 - Ø16	36.025.01
	Ø18 - Ø18	211.119.01

Lige indskruninger

Illustration	Dimension	Bestillingsnr.
	Ø6 - M10x1	20.410.01
	Ø6 - M12x1,5	20.431.01
	Ø6 - M16x1,5	211.004.01
	Ø6 - M22x1,5	211.005.03
	Ø8 - M10x1	20.004.01
	Ø8 - M12x1,5	20.211.01
	Ø8 - M14x1,5	20.437.01
	Ø8 - M16x1,5	211.008.01
	Ø8 - M22x1,5	211.009.03
	Ø8 - 1/2"	50.036.01
	Ø10 - M12x1,5	20.442.01
	Ø10 - M14x1,5	20.412.01
	Ø10 - M16x1,5	211.011.01
	Ø10 - M22x1,5	211.013.03
	Ø12 - M12x1,5	760151
	Ø12 - M14x1,5	20.447.01
	Ø12 - M16x1,5	20.213.01
	Ø12 - M22x1,5	211.018.03
	Ø15 - M16x1,5	20.452.01
	Ø15 - M22x1,5	211.019.03
Ø16 - M22x1,5	20.225.01	
Ø18 - M22x1,5	20.415.01	

Konventionelle fittings

Påskruninger

Illustration	Dimension	Bestillingsnr.
	Ø6 - M22x1,5	49.033.01
	Ø8 - M22x1,5	49.037.01
	Ø10 - M22x1,5	49.041.01
	Ø12 - M22x1,5	49.044.01

T-forskruning

Illustration	Dimension	Bestillingsnr.
	Ø6 - Ø6 - Ø6	36.410.01
	Ø8 - Ø8 - Ø8	36.411.01
	Ø10 - Ø10 - Ø10	36.412.01
	Ø12 - Ø12 - Ø12	36.413.01

Lige Skot-samlere

Illustration	Dimension	Bestillingsnr.
	Ø6 - Ø6	47.010.01
	Ø8 - Ø8	47.011.01
	Ø10 - Ø10	47.012.01
	Ø12 - Ø12	47.013.01
	Ø15 - Ø15	211.202.01
	Ø16 - Ø16	47.025.01

Lige Skot-indskruninger

Illustration	Dimension	Bestillingsnr.
	Ø10 - M16x1,5	211.424.01
	Ø10 - M22x1,5	761900
	Ø12 - M16x1,5	211.425.01
	Ø12 - M22x1,5	211.423.02
	Ø15 - M22x1,5	211.202.06

Vinkel Skot-indskruninger

Illustration	Dimension	Bestillingsnr.
	Ø6/Ø6 - M12x1,5	47.210.01
	Ø8/Ø8 - M14x1,5	760571
	Ø10/Ø10 - M16x1,5	47.212.01
	Ø12/Ø12 - M18x1,5	47.213.01
	Ø15/Ø15 - M22x1,5	212.181.02

Vinkel skot-påskruning

Illustration	Dimension	Bestillingsnr.
	Ø10 / U=M16x1,5 / I=M16x1,5	212.125.01
	Ø15 / U=M22x1,5 / I=M22x1,5	212.121.01

Vinkel skot-påskruninger

Illustration	Dimension	Bestillingsnr.
	Ø6 - M12x1,5	51.031.01
	Ø6 - M16x1,5	760462
	Ø8 - M12x1,5	51.011.01
	Ø8 - M16x1,5	84.037.01
	Ø8 - M22x1,5	84.038.01
	Ø10 - M12x1,5	51.042.01
	Ø10 - M14x1,5	51.012.01
	Ø10 - M16x1,5	84.039.01
	Ø10 - M22x1,5	51.045.01
	Ø12 - M16x1,5	51.013.01
	Ø12 - M22x1,5	51.049.01
	Ø15 - M22x1,5 (med skæring)	51.053.01
	Ø15 - M16x1,5	212.005.01
	Ø15 - M22x1,5 (med trykring)	212.003.02
	Ø16 - M22x1,5	212.008.01
Ø18 - M22x1,5	212.010.02	

Reduktionsmuffer

Illustration	Dimension	Bestillingsnr.
	M22x1,5 - M12x1,5	200.516.00
	M22x1,5 - M14x1,5	200.517.00
	M22x1,5 - M16x1,5	200.518.00
	M22x1,5 - 1/4"	761878

Omløbermøtrikker

Illustration	Dimension	Bestillingsnr.
	Ø6 - M12x1,5	15.010.01
	Ø8 - M14x1,5	15.011.01
	Ø10 - M16x1,5	15.012.01
	Ø12 - M18x1,5	15.013.01
	Ø15 - M22x1,5	15.014.01
	Ø16 - M22x1,5	15.014.61
	Ø18 - M22x1,5	15.015.01

Indstiksbøsninger

Illustration	Dimension	Bestillingsnr.
	Ø4x1 - diameter 2,0 mm	762990
	Ø6x1 - diameter 4,0 mm	762699
	Ø8x1 - diameter 6,0 mm	762693
	Ø10x1 - diameter 8,0 mm	762694
	Ø10x1,25 - diameter 7,0 mm	7626945
	Ø10x1,5	200.707.00
	Ø12x1,5 - diameter 9,0 mm	762695
	Ø15x1,5 - diameter 12,0 mm	762696
	Ø18x2,0 - diameter 14,0 mm	762697
	Ø1/4" - diameter 4,2 mm	475 1/4
	Ø3/8" - diameter 6,2 mm	475 3/8
	Ø1/2" - diameter 9,45 mm	475 1/2

Skæreringe

Illustration	Dimension	Bestillingsnr.
	Ø6	15.210.05
	Ø8	15.211.05
	Ø10	15.212.05
	Ø12	15.213.05
	Ø15	15.214.05
	Ø16	15.225.05
	Ø18	15.215.05

Gevindpakninger

Illustration	Dimension	Bestillingsnr.
	M10x1,0	762291
	M12x1,5	762300
	M14x1,5	200.204.00
	M16x1,5	762420
	M18x1,5	200.206.00
	M22x1,5	762330

O-ringe

Illustration	Dimension	Bestillingsnr.
	M10x1,0	762292
	M12x1,5	762310
	M14x1,5	200.254.00
	M16x1,5	762430
	M18x1,5	200.256.00
	M22x1,5	762340

Overgangsstykker

Illustration	Dimension	Bestillingsnr.
	U=M12x1,5 / l=M22x1,5	7618810
	U=M14x1,5 / l=M22x1,5	49.137.01
	U=M16x1,5 / l=M22x1,5	49.141.01
	U=M22x1,5 / l=M22x1,5	7618820
	U=M22x1,5 / l=1/4"	200.524.00
	U=M22x1,5 / l=3/8"	200.532.00
	U=M22x1,5 / l=1/2"	200.528.00

Samlemuffer

Illustration	Dimension	Bestillingsnr.
	M12x1,5 - M12x1,5	893.209.065.4
	M16x1,5 - M14x1,5	200.405.00
	M16x1,5 - M16x1,5	893.209.066.4
	M22x1,5 - M22x1,5	200.357.00

Slangestudser

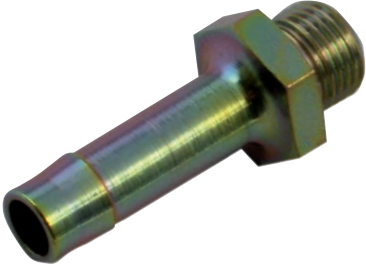
Illustration	Dimension	Bestillingsnr.
	Ø8x5 - M16x1,5	760835
	Ø11x3,5/4,0 - M16x1,5	760830
	Ø11x3,5/4,0 - M22x1,5	760832
	Ø13x6 - M16x1,5	760840
	Ø13x6 - M22x1,5	760850

Slangestudser for omløber

Illustration	Dimension	Bestillingsnr.
	Ø11x3,5/4,0	760821
	Ø13x6	205.003.00
	Omløber - M22x1,5	15.014.61

Vinkelforskruninger - stilbare

Illustration	Dimension	Bestillingsnr.
	Ø6	56.010.01
	Ø8	56.011.01
	Ø10	56.012.01
	Ø12	56.013.01

Konventionelle fittings

T-forskruninger - stilbare

Illustration	Dimension	Bestillingsnr.
	Ø6	57.010.01
	Ø8	57.011.01
	Ø10	57.012.01
	Ø12	57.013.01

T-forskruninger - stilbare

Illustration	Dimension	Bestillingsnr.
	Ø8	58.011.01
	Ø10	58.012.01
	Ø12	58.013.01

Lige plast samlere - ikke for bremsesystemer

Illustration	Dimension	Bestillingsnr.
	Ø4	76782000
	Ø5	76782001
	Ø6	76782002
	Ø8	76782003
	Ø10	76782004
	Ø12	76782005
	Ø3/16"	7009317
	Ø1/4"	7009318
	Ø3/8"	7009319
	Ø1/2"	7009320

Plast vinkelstykker - ikke for bremsesystemer

Illustration	Dimension	Bestillingsnr.
	Ø4	76784000
	Ø5	76784001
	Ø6	76784002
	Ø8	76784003
	Ø10	76784004
	Ø12	76784005

Plast T-stykker - ikke for bremsesystemer

Illustration	Dimension	Bestillingsnr.
	Ø4	76783000
	Ø5	76783001
	Ø6	76783002
	Ø8	76783003
	Ø10	76783004
	Ø12	76783005

Prøveudtag med udvendigt gevind

Illustration	Dimension	Bestillingsnr.
	M12x1,5	210.841.01
	M14x1,5	763512
	M16x1,5	715008
	M22x1,5	763510

Prøveudtag med indvendigt gevind

Illustration	Dimension	Bestillingsnr.
	M12x1,5	463.703.116.0
	M14x1,5	763542
	M16x1,5	763543
	M22x1,5	763540

Afvandingsventil

Illustration	Dimension	Bestillingsnr.
	M22x1,5	762490
	Automatisk	315.016.001

Vingemøtrik

Illustration	Beskrivelse	Bestillingsnr.
	Med slangestuds & pakning.	763580

Plastrør og bremseslanger

25 m ruller

Illustration	Dimension	Bestillingsnr.
	4x1	500025
	5x1	500225
	6x1	500525
	8x1	501025
	9x1,5	549025
	10x1	501525
	10x1,25	502025
	10x1.5	502225
	11x1,5	502325
	12x1,5	502525
	14x2	502825
	15x1,5	503025
	15x2	503225
	16x2	503525
	18x2	504025
	1/4"	505025
1/2"	505525	
5/8"	506525	

100 m Ruller

Illustration	Dimension	Bestillingsnr.
	6x1	5005100
	8x1	5010100
	10x1	5015100
	10x1.25	5020100
	10x1.5	5022100
	12x1,5	5025100
	15x1,5	5030100
	15x2	5032100

Skæretang

Illustration	Beskrivelse	Bestillingsnr.
	Skæretang for nylonrør	TTF0002
	Reserveblad for do	TTF9003

Bremseslange - 40 m ruller

Illustration	Dimension	Bestillingsnr.
	11 x 3,5	751135
	13x6	751360
	15x5	751550

Diverse

Elektro-kabel

Illustration	Dimension	Bestillingsnr.
	Omløber Ø27 mm	1001400
	Omløber Ø24 mm	1001500



Varmeapparater

Illustration	Dimension	Bestillingsnr.
	Scania serie 4 vand-ventil for varmeapparat til køretøjer med aircondition	70122314

Diverse

Illustration	Beskrivelse	Bestillingsnr.
	Wabco manometer ur 0-10 bar	453.004.005.0
	Wabco manometer ur 0-16 bar	453.004.007.0
	Uniflex slange 3/16 for manometre	3154
	Vingemøtrik komplet	763580
	22 mm	769480
	Bendix drosselventil	SEB00778
	Uni-tape 12mm x 12 mtr. Gevindtape 0,05 mm	999 856 507

Diverse

Illustration	Beskrivelse	Bestillingsnr.
	Haldex diagnosekuffert	815 028 001
	Knorr diagnosekuffert	TR DIAGNOSEKIT
	Wabco mont.fedt - West 1, 1000 gr	830.503.065.4

A		
	ABS tilbehør	65 - 68
	ABS-ventiler	61 - 64
	Afspærrehaner	95
	ALB-ventiler	31 - 39
	Anhængerbremsventiler	29 - 30
	Anhængerstyreventiler	28
	Arbejds cylindre	79
B		
	Betjeningsbokse	59 - 60
D		
	Diverse	148
	Duomatic luftkoblinger	106 - 107
E		
	ECAS-ELC-dele	75 - 76
	EBS ventiler	69 - 72
	ECAS-ELC-ventiler	73 - 74
F		
	Fjederbremsecylindre	98 - 100
	Fodbremseventiler	48 - 50
	Førerhusniveauventiler	81 - 82
	4-Kreds beskyttelsesventiler	18 - 21
G		
	Gearskifteventiler	54
H		
	Hurtigudløserventiler	42 - 43
	Hæve- sænkeventiler	25 - 27
	Håndbremseventiler	16 - 17
K		
	Kompressorer	12 - 15
	Kontraventiler	78
	Konventionelle fittings	132 - 145

L	Liftakselventiler	40 - 41
	Luftkoblinger	114 - 116
	Lufttørrere	5 - 11
	Lynfittings - plug-in	125 - 128
	Lynfittings - sortiment	129 - 131
	Lynfittings - standard	117 - 124
	Løsnerventiler	44 - 47
M	Magnetventiler	89 - 93
	Membrancylindre	96 - 97
N	Niveauventiler	83 - 87
O	Overstrømningsventiler	51
P	Plastrør og bremseslanger	146 - 147
	Proportionalventiler	88
R	Reguleringsventiler	77
	Relæventiler	22 - 24
S	Sikkerhedsventiler	55
	Spære-ventiler/cylindre	80
	Stempelcylindre	94
T	Tilbehør fjederbremse og membrancylindre	101 - 103
	Trykbegrænsningsventiler	56 - 57
	Trykluftbeholdere	104 - 105
	Trykluft-spiralslanger	108 - 113
	Trykregulatorer	58
	3/2, 4/2, 5/2-vejs ventiler	52 - 53

Hos BESKO er fleksibilitet og kundetilpassede løsninger nogle af de nøgleord, der danner grundlaget for at kunne tilbyde kunder de mest optimale løsninger. BESKO's medarbejderteam har mange års erfaring og stort branchekendskab til de særlige forhold, der gælder inden for den tunge transportsektor.

BESKO stræber hver dag efter at leve op til deres målsætning om at tilbyde kunden en professionel betjening samt den rigtige reservedel på det rette tidspunkt og til det rette sted.



Hos os finder du
alt til dit værksted



Aalborg
Troensevej 6A
9220 Aalborg
Tlf. 96 32 26 00

Herning
Hvidelvej 8A
7400 Herning
Tlf. 96 60 10 20

Aarhus
Logistikparken 24
8220 Brabrand
Tlf. 87 94 17 00

Kolding
Vranderupvej 2
6000 Kolding
Tlf. 76 35 31 00

Odense
Emil Neckelmanns Vej 15G
5220 Odense SØ
Tlf. 63 12 11 00

Padborg
Plantagevej 8B
6330 Padborg
Tlf. 74 67 02 22

Greve
Geminivej 27
2670 Greve
Tlf. 43 90 25 00

BESKO

Member of the
 Aftermarket
Group